



LEGENDS OF **CHIMA**™



70227



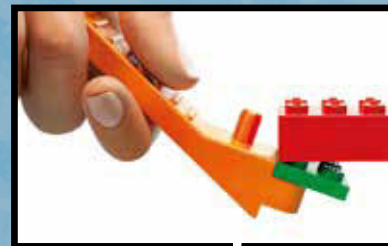

LEGO.com/brickseparator

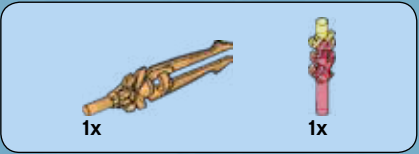
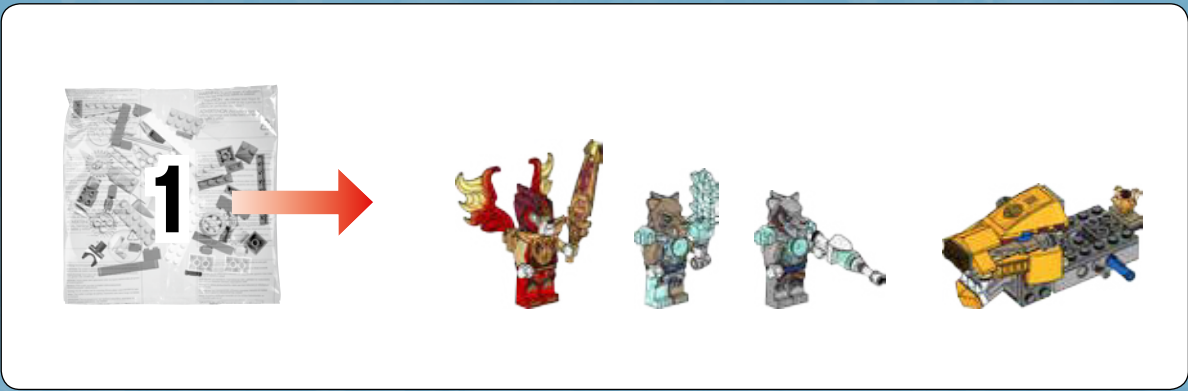



1x



1x



1x



1x



1x



1x

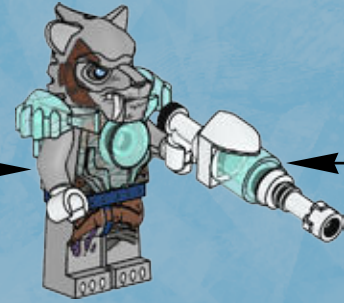
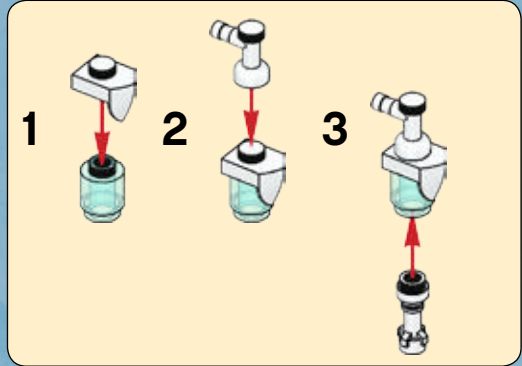
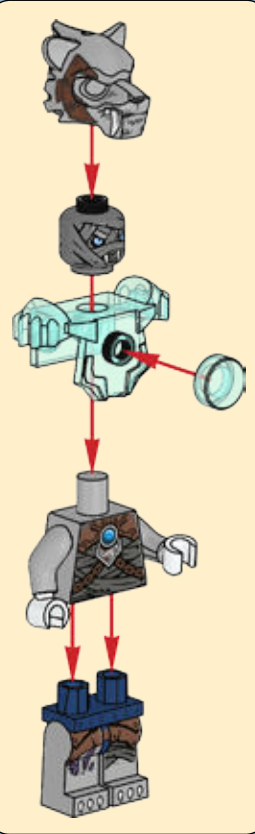
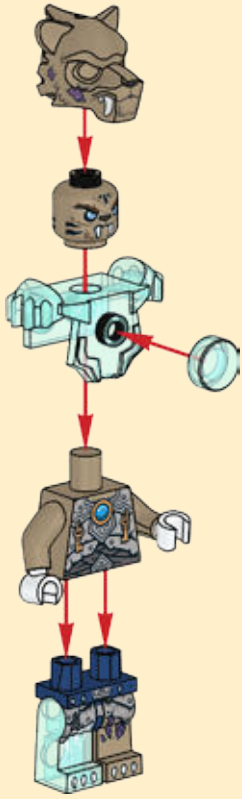

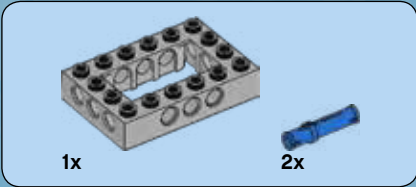
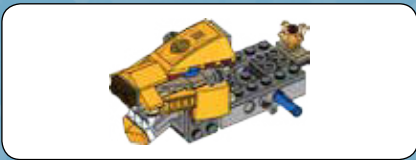

1

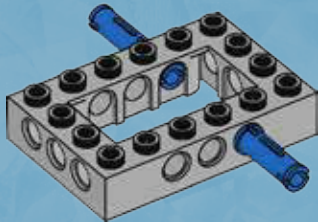

2

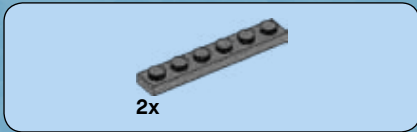
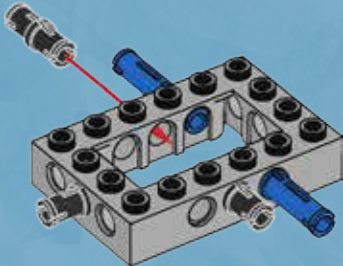

3

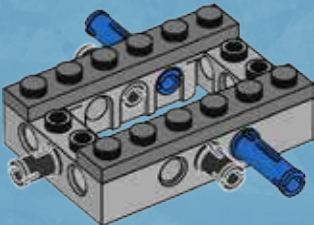

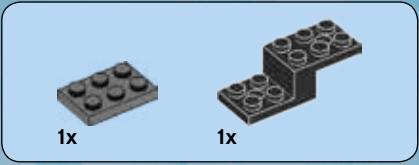

4

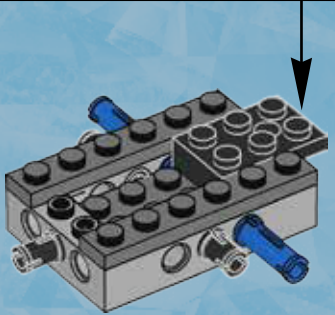
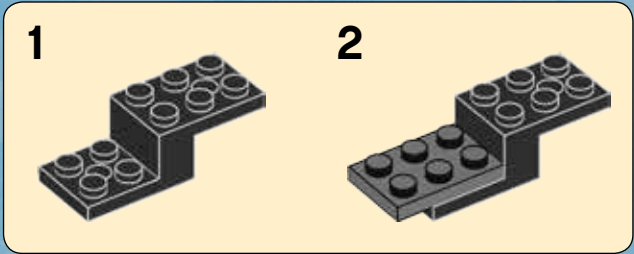

5

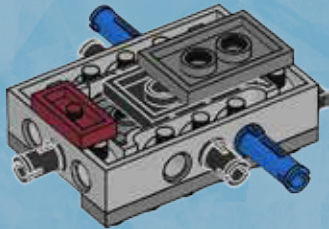



6

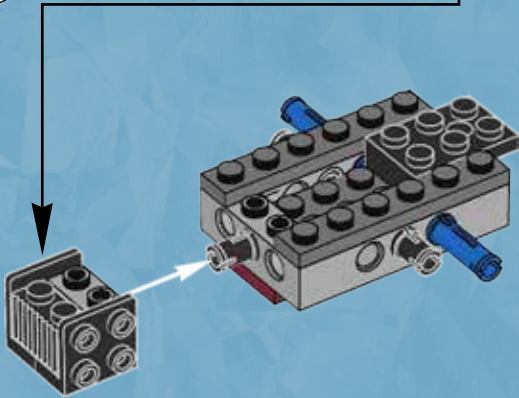
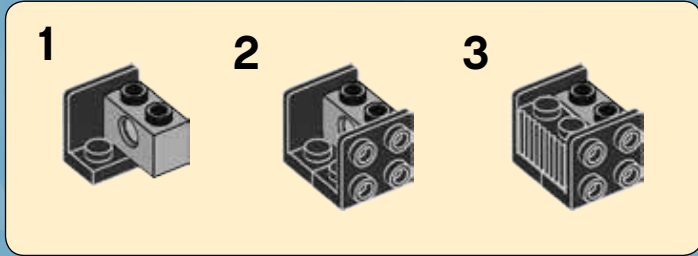

7

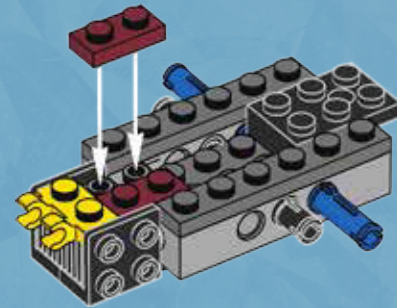

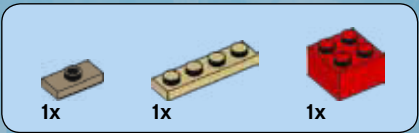

8

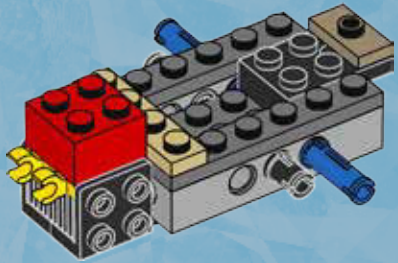

9

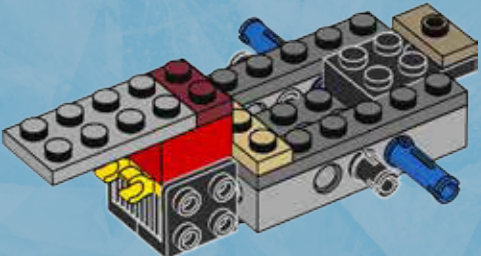

10

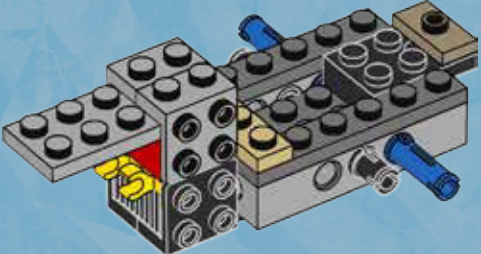



1x

11

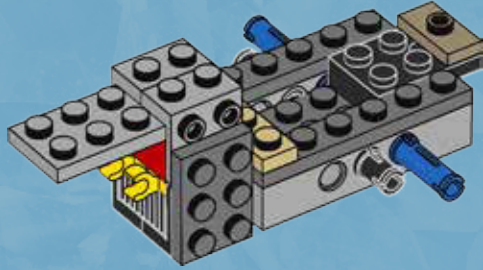

1x

12

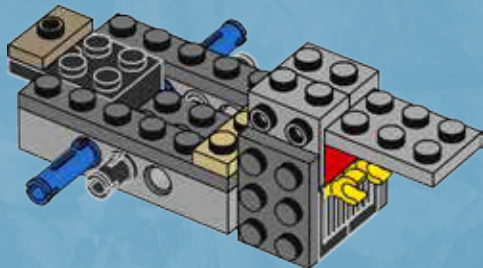

1x



1x



2x



1x

13

1

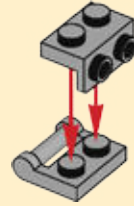

2

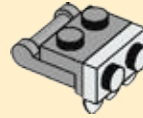

3

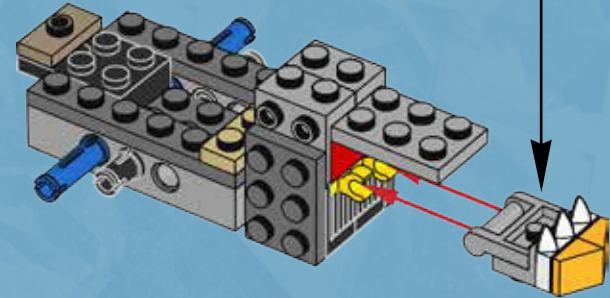
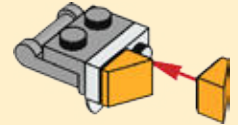



2x

14

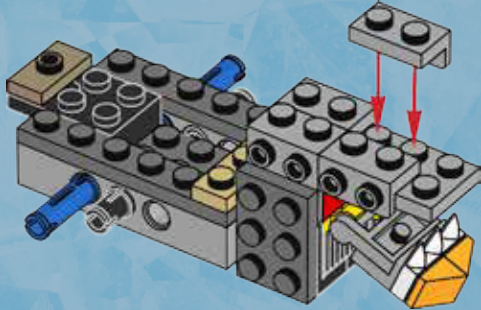

2x



2x

16

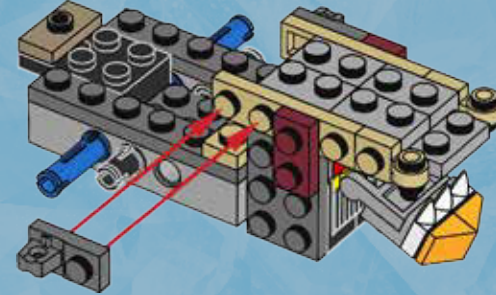

2x



2x

15

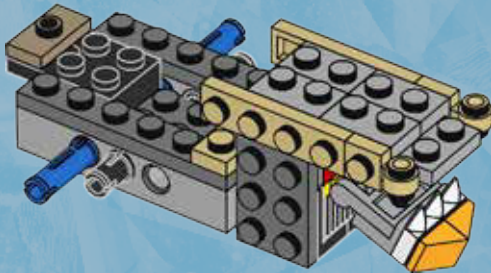

2x

17

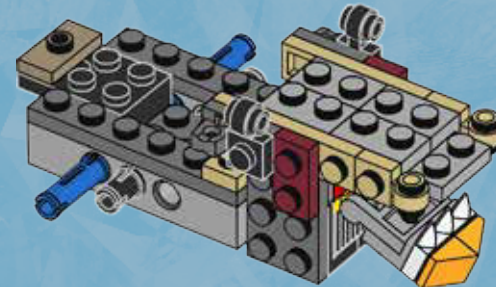



2x



2x

18

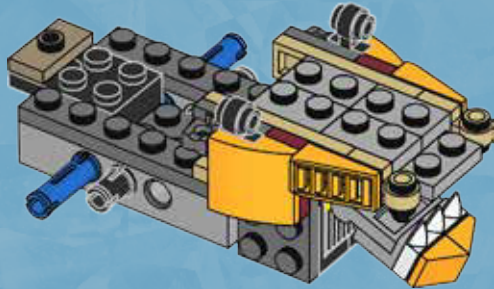

2x

19

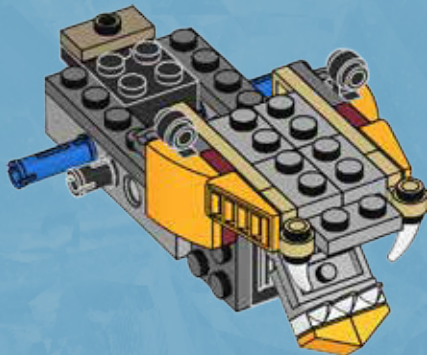

1x



2x

20

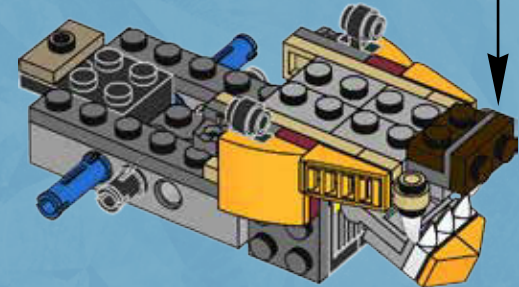
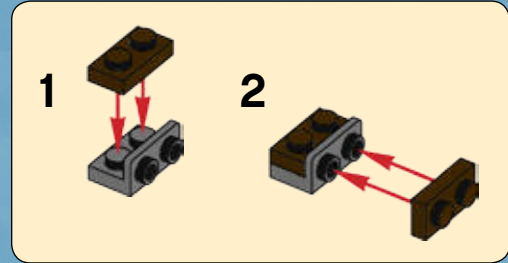



1x



2x

21

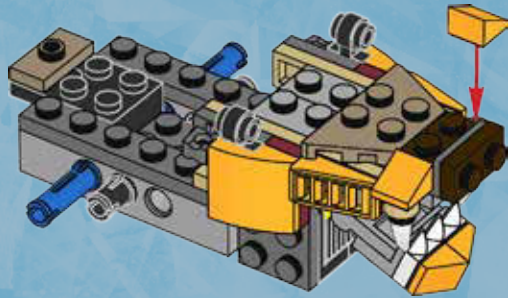

1x



2x

22

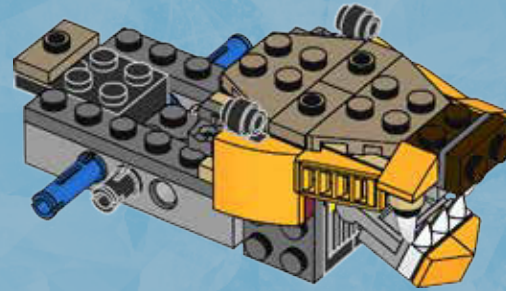

2x



2x



1x



1x

23

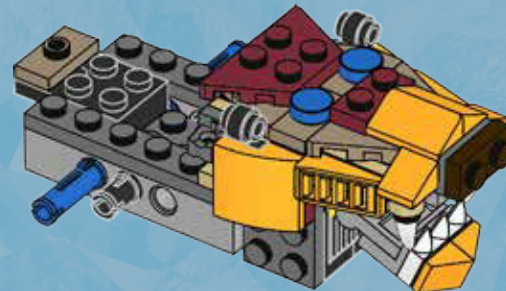



24

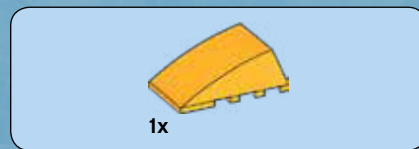
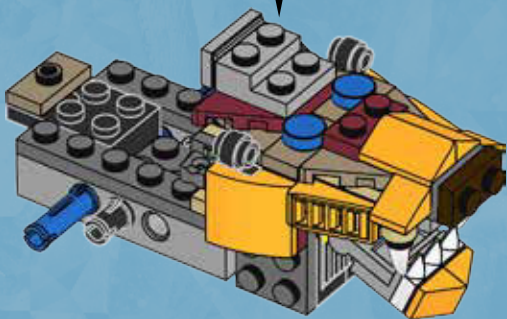
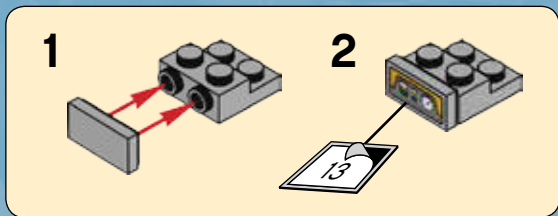

25

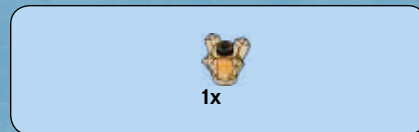
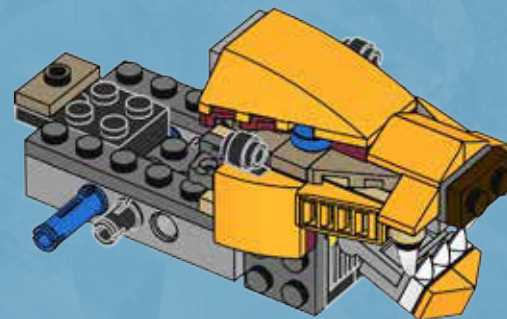

26

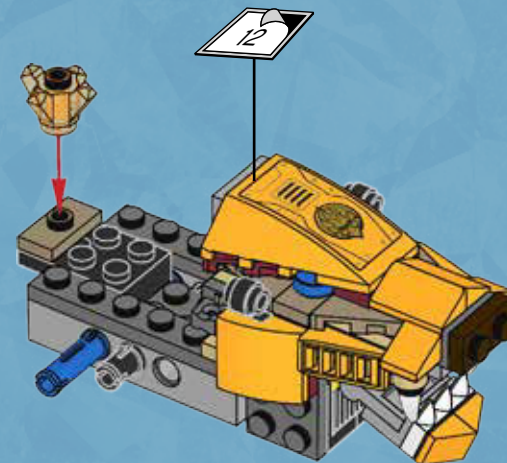

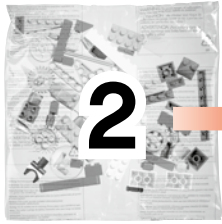

2

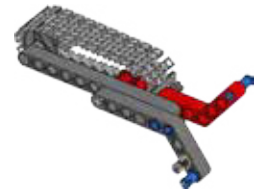

1

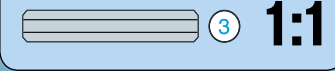
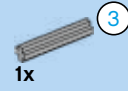
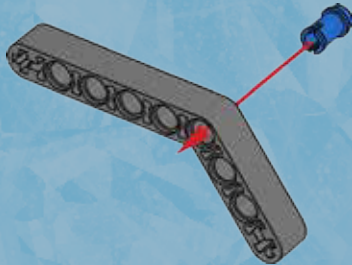

2

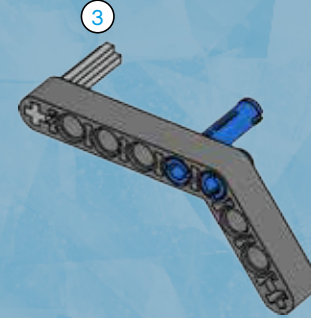

3

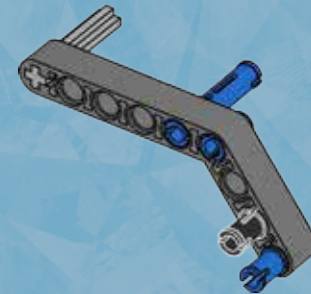

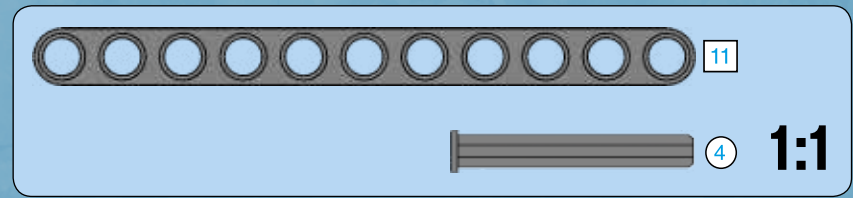
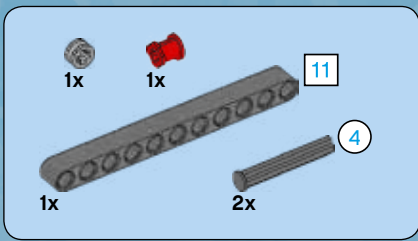

4

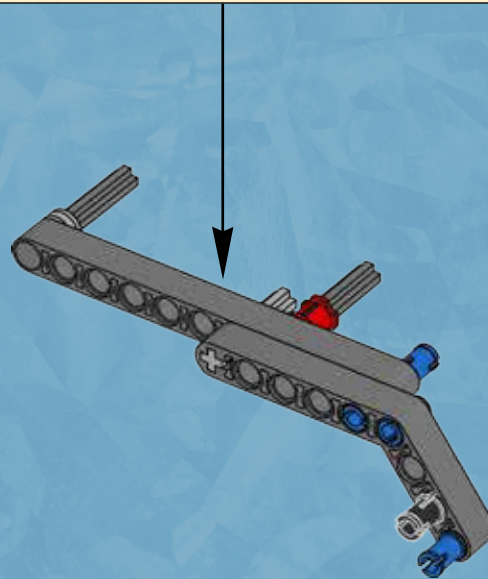
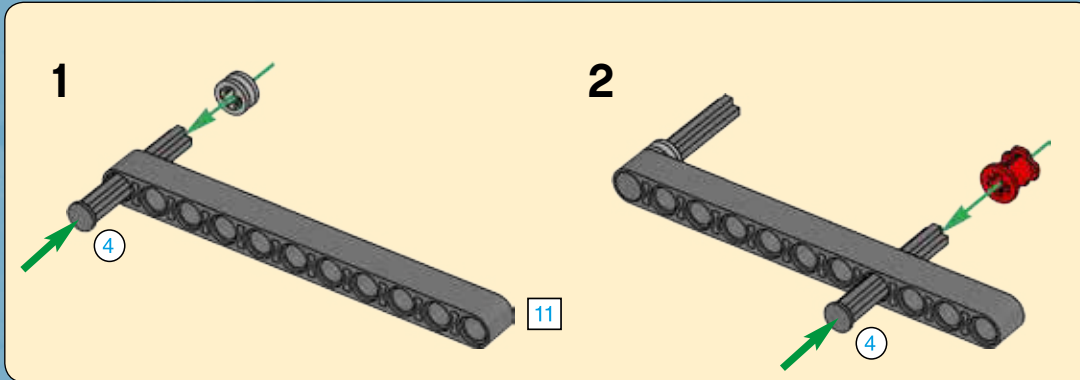



1x

5

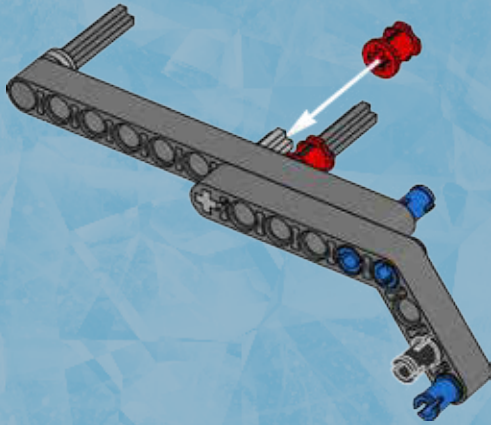

1x

1x

1x

6

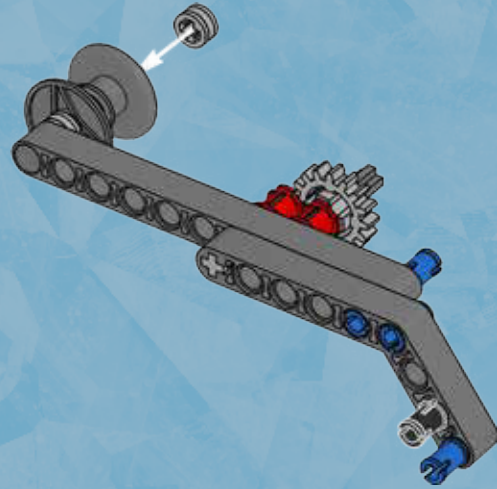



7

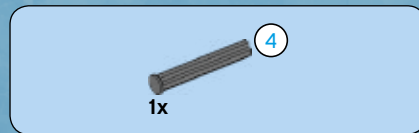
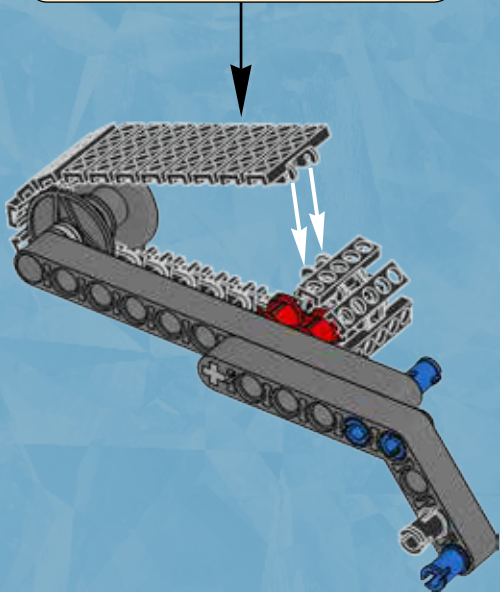
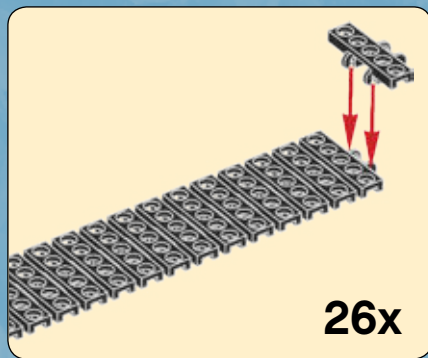

8

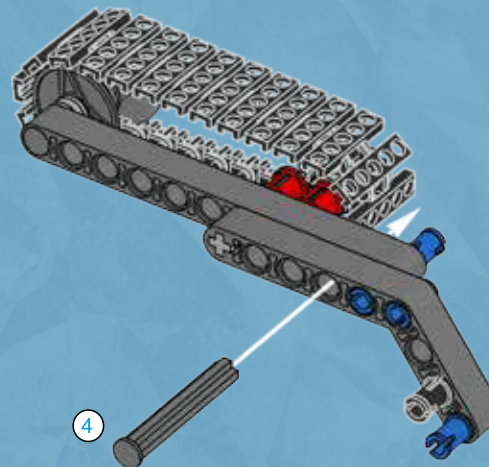
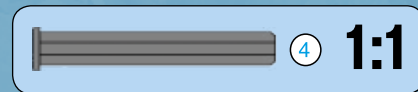

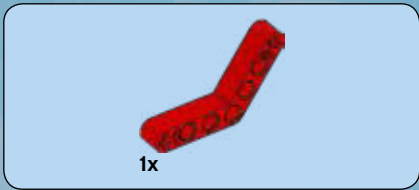

9

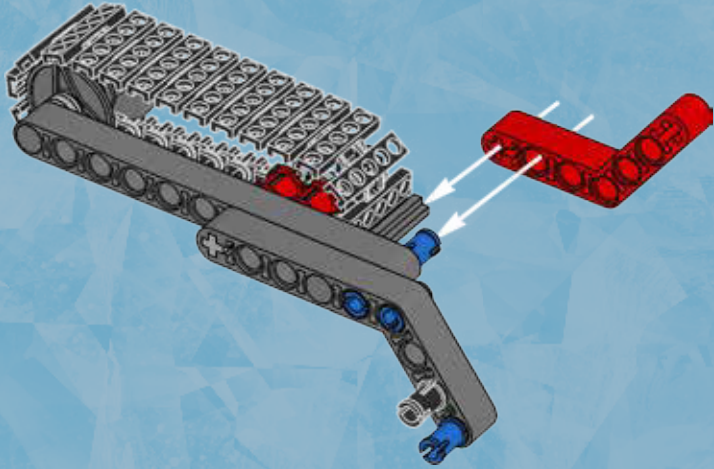

10

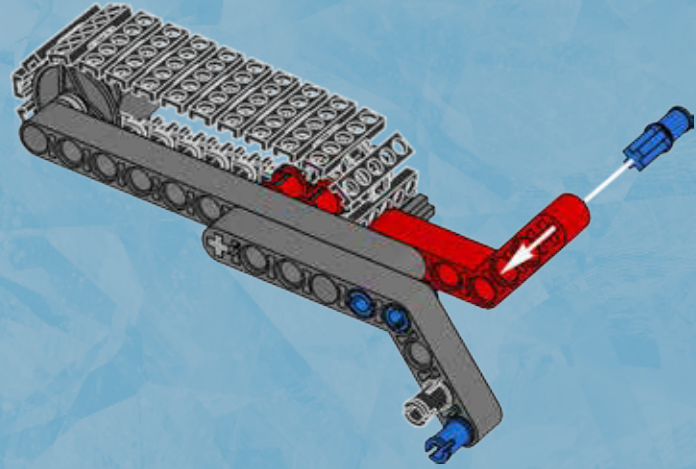



27

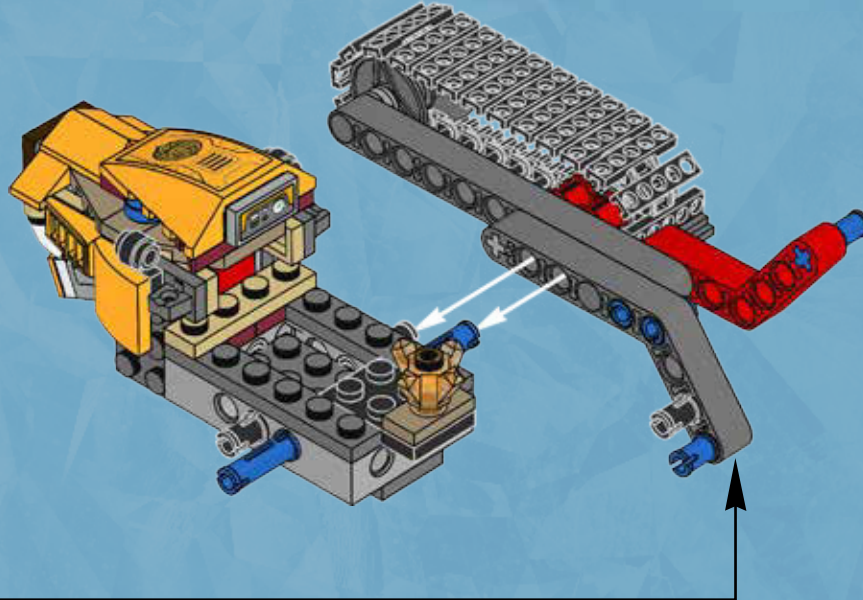

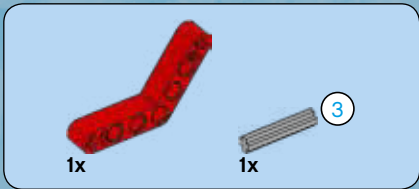
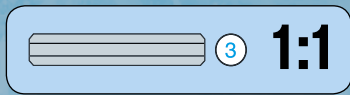

1

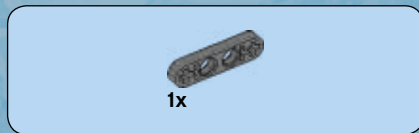
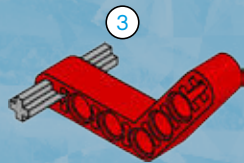

2

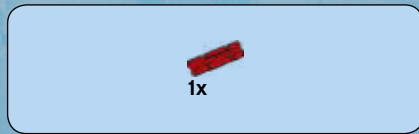
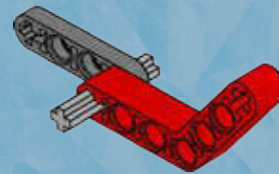

3

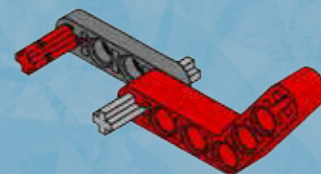

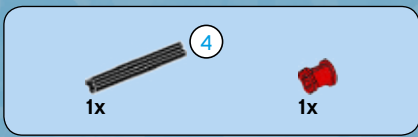

4

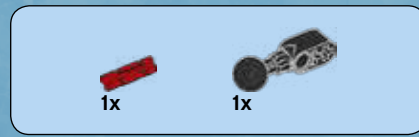
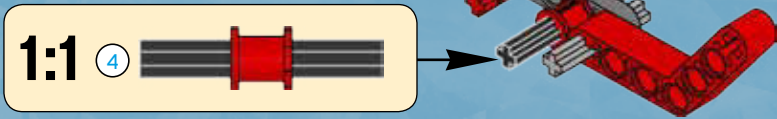

5

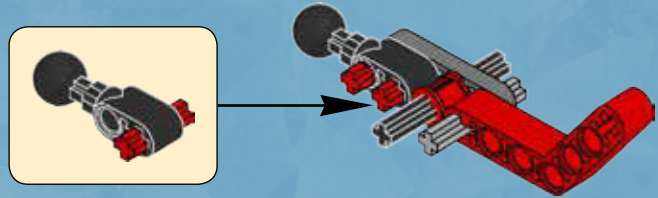

6



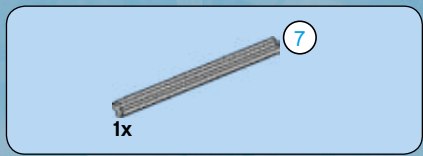

7

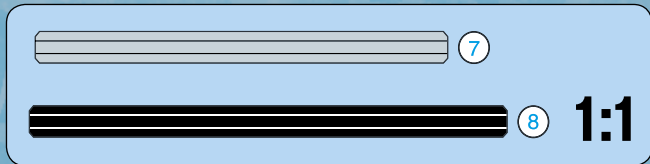
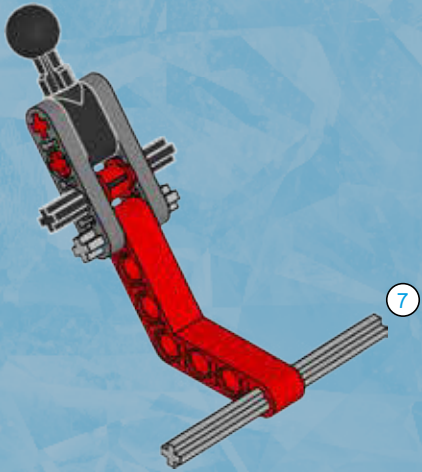

8

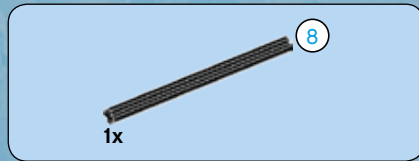
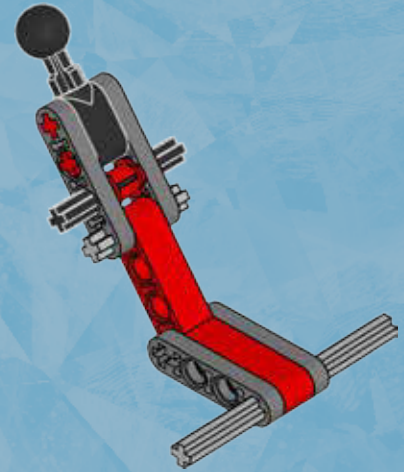

9

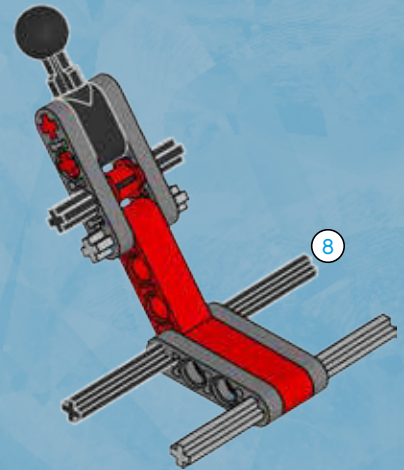

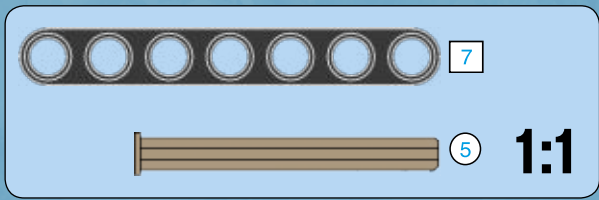
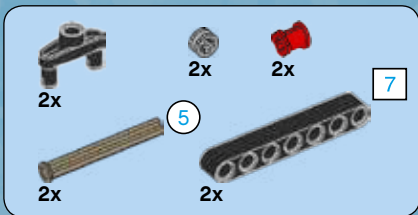

10

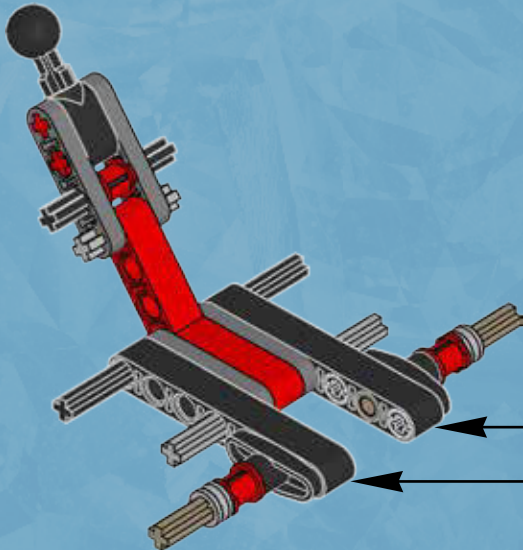
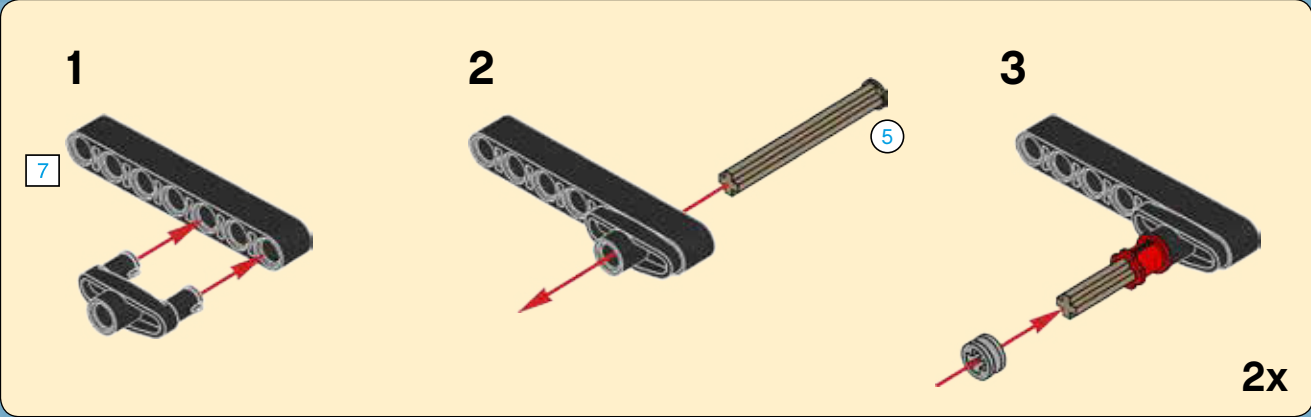



2x

11

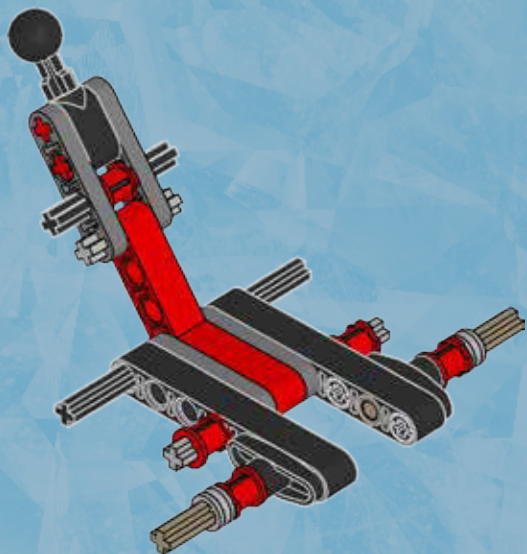

28

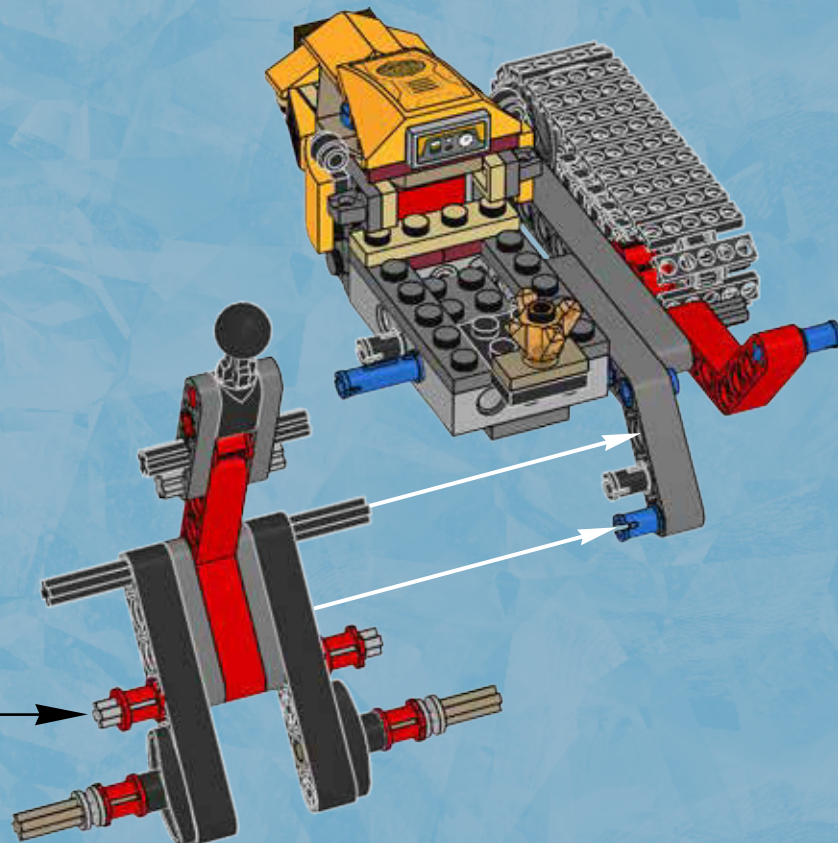

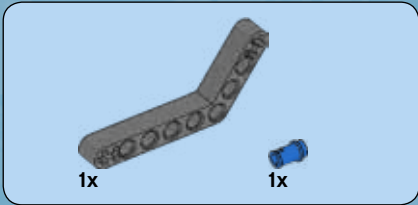
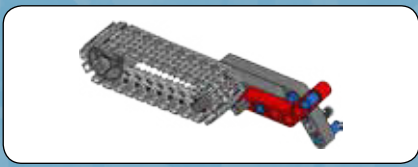

1

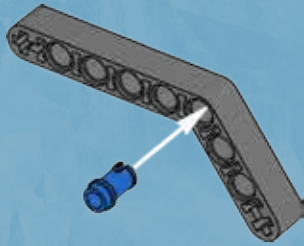

2

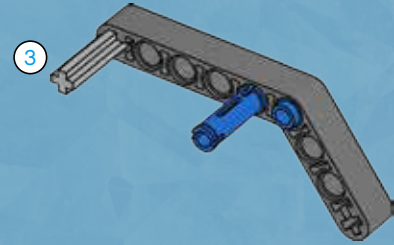

3

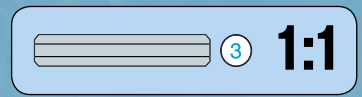
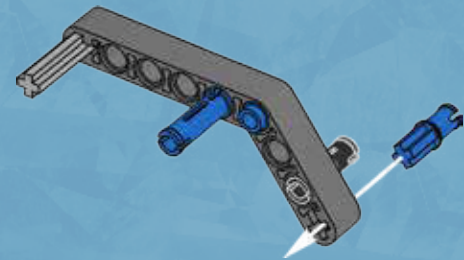

1:1

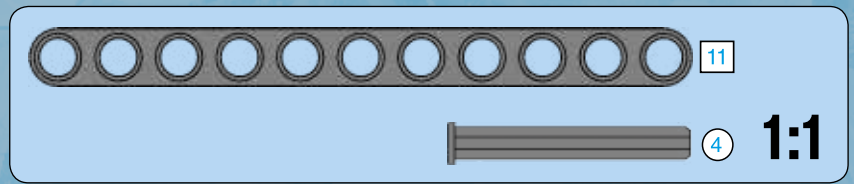
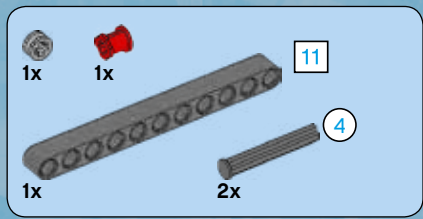

4

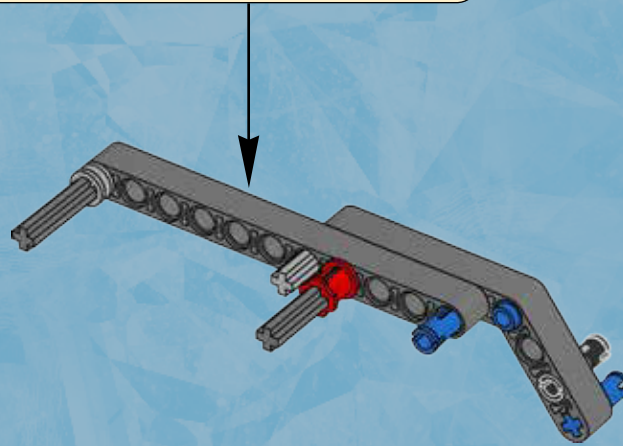
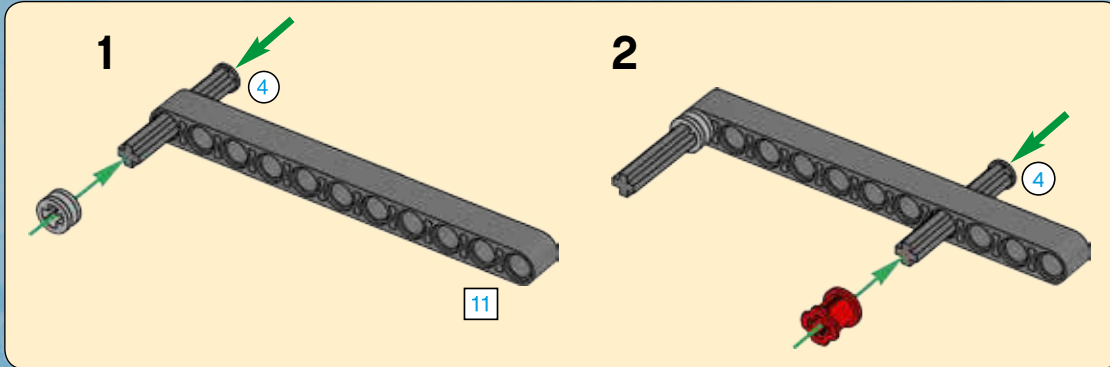



1x

5

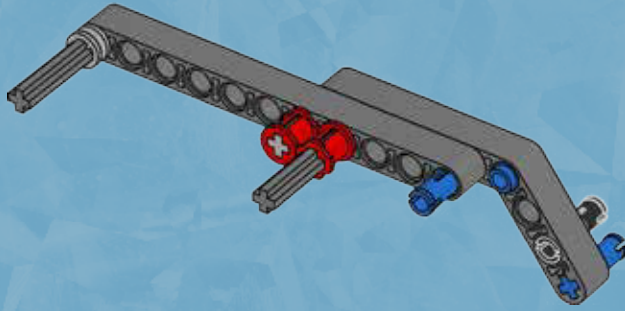

1x

1x

1x

6

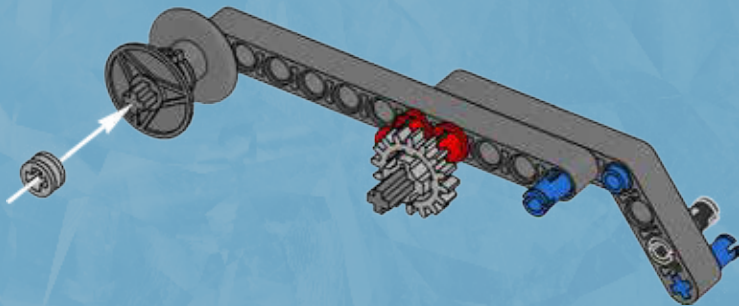

26x

7

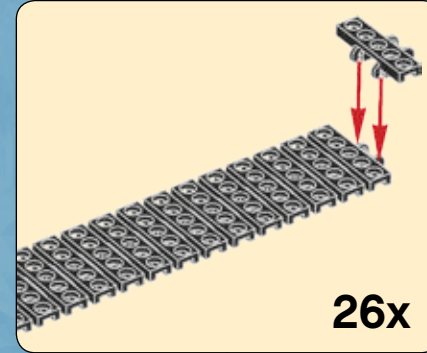

26x

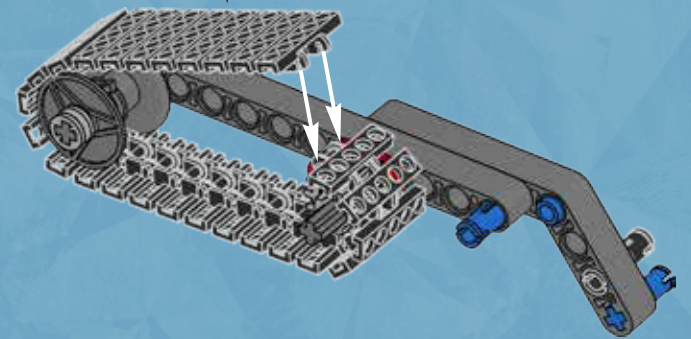

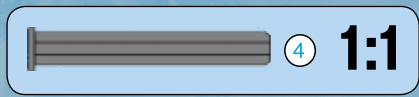
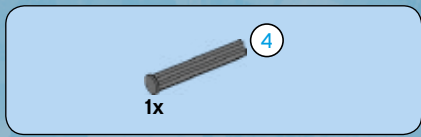

8

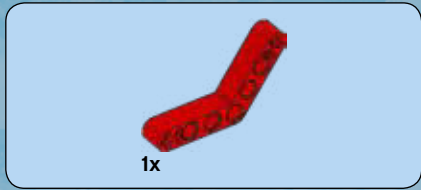
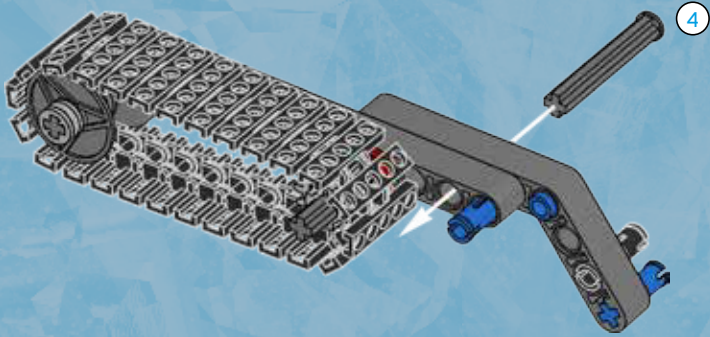

9

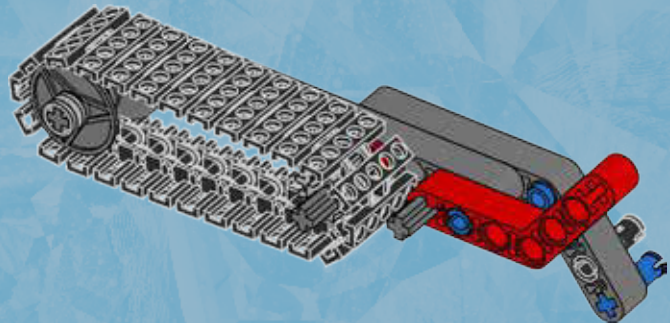

10

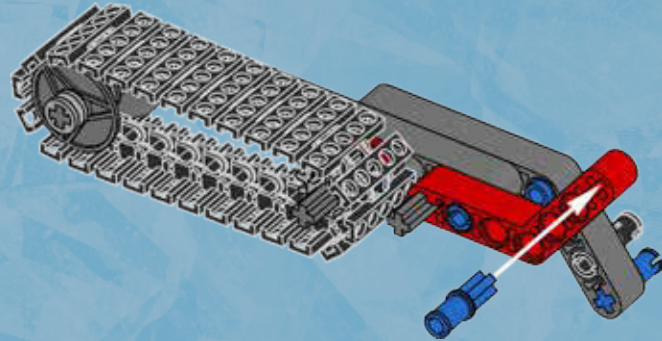

29

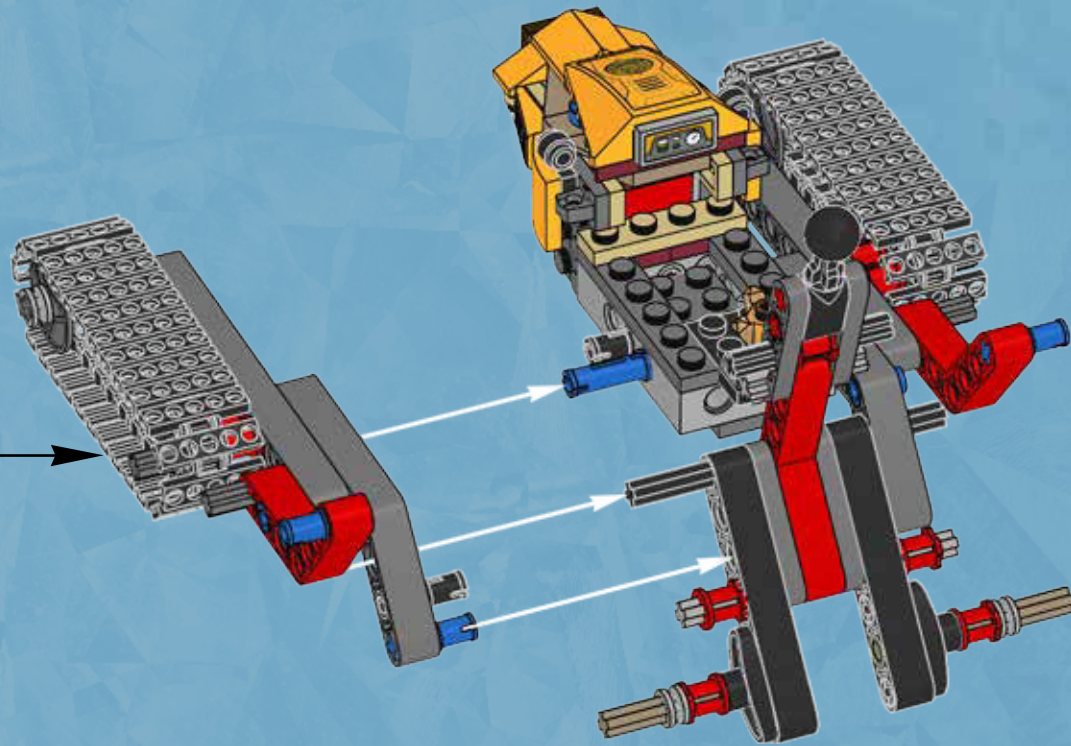



2x

30

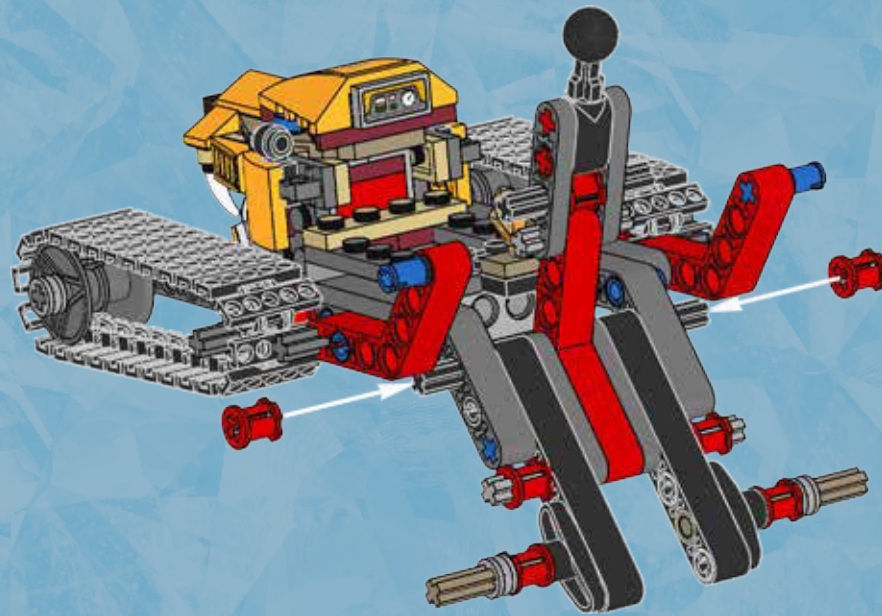

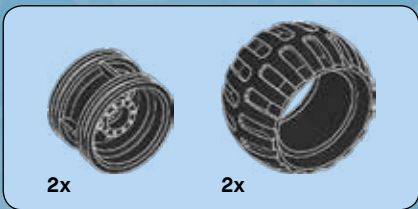

31

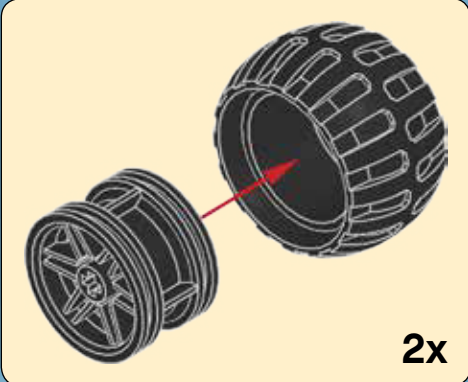
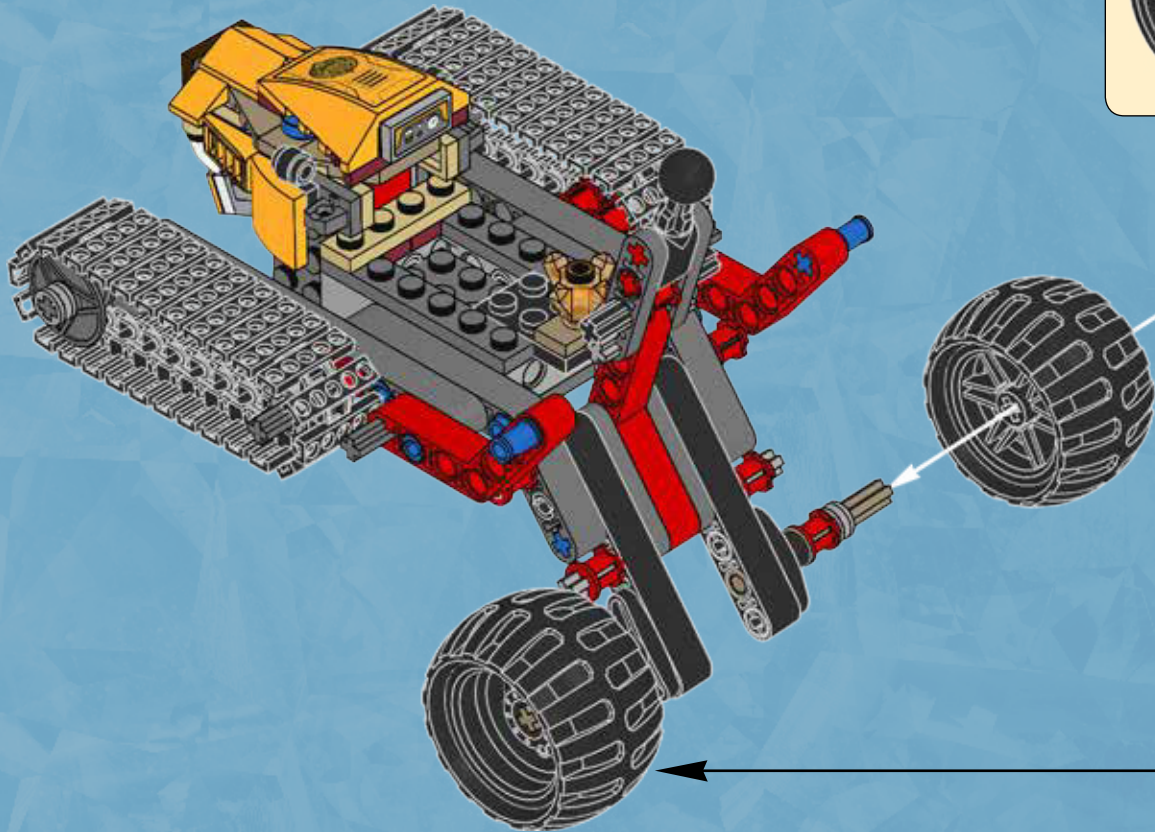



2x

32

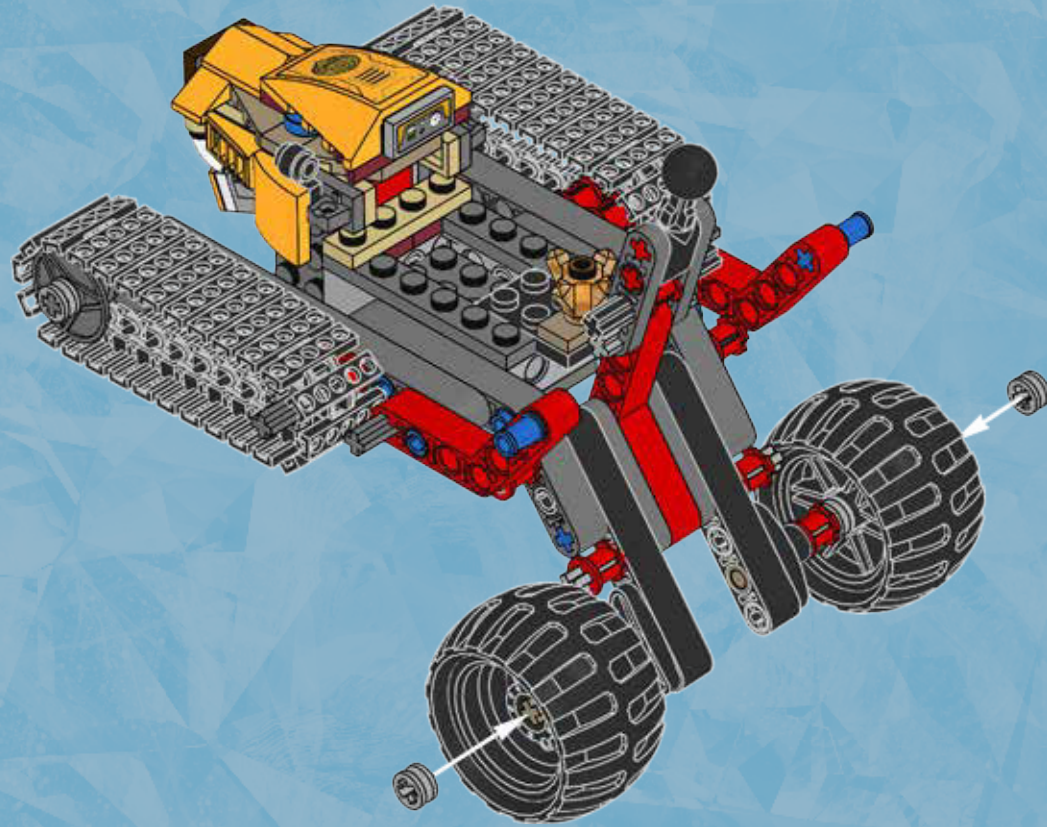

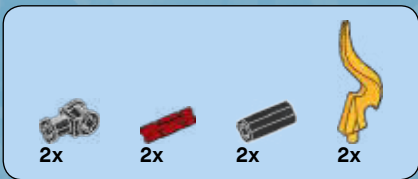

33

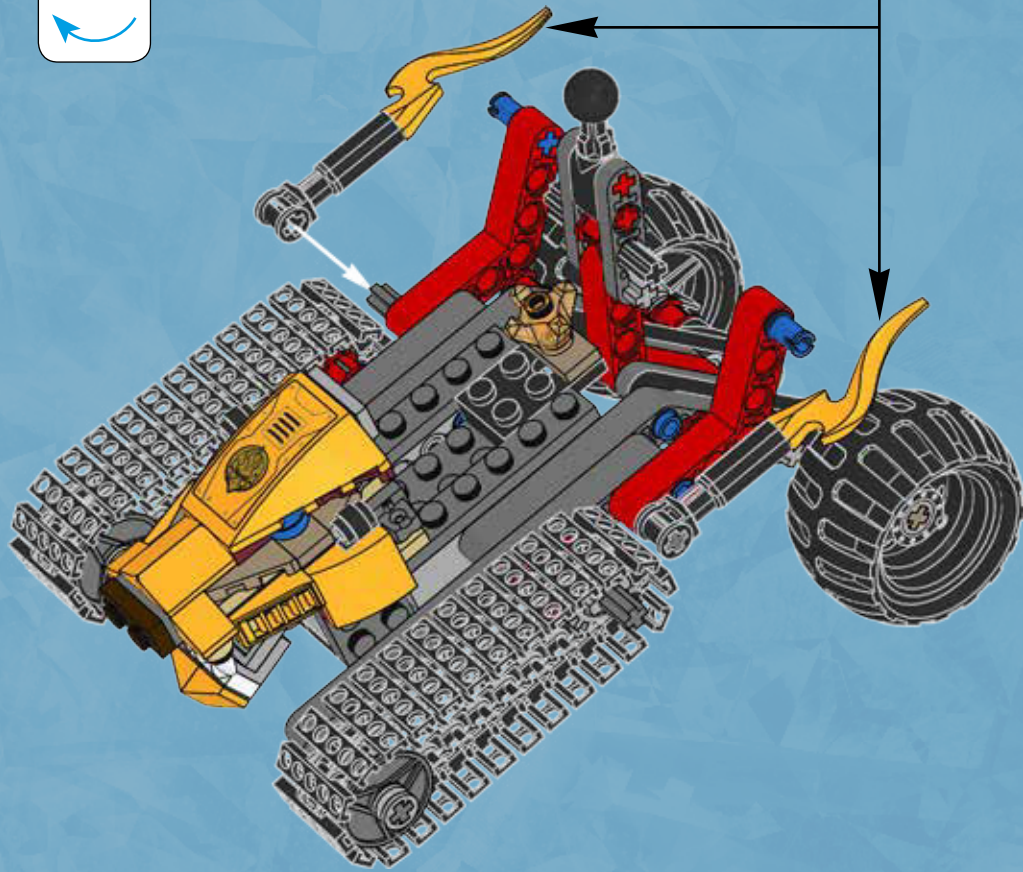

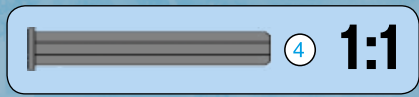
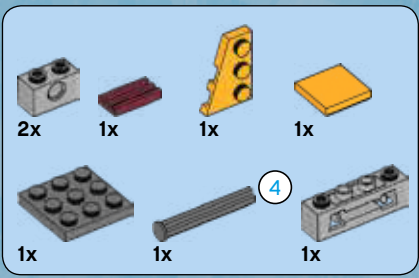

34



1



2

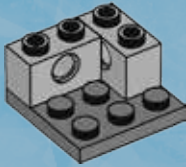

3

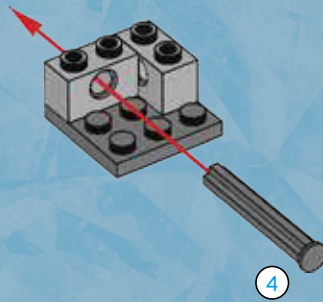

4

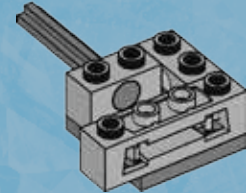

5

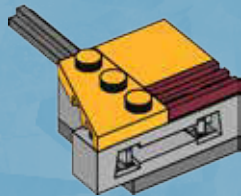

6

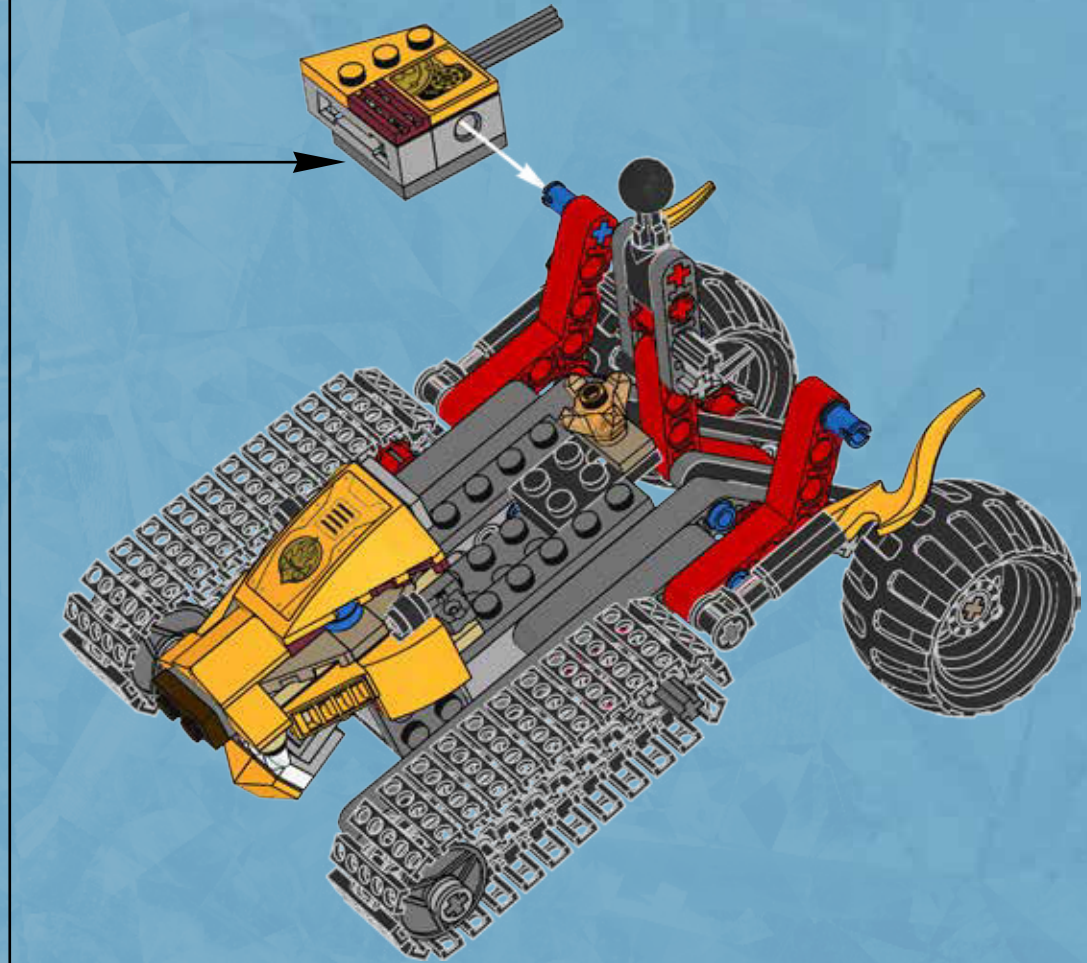

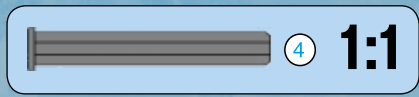
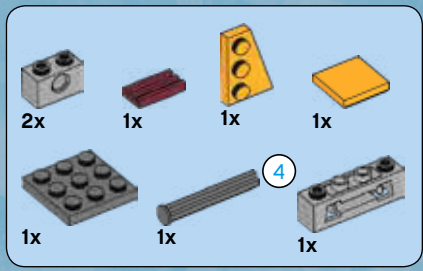

35



1

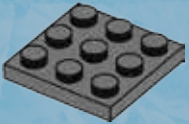

2

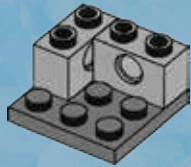

3

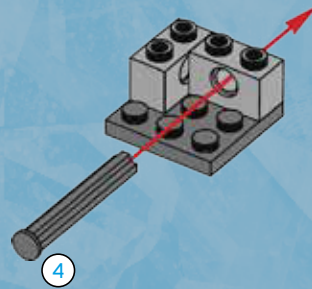

4

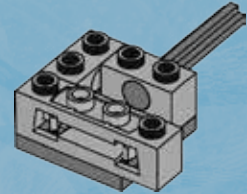

5

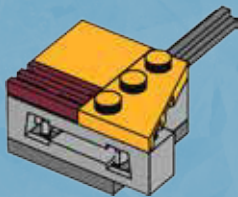

6

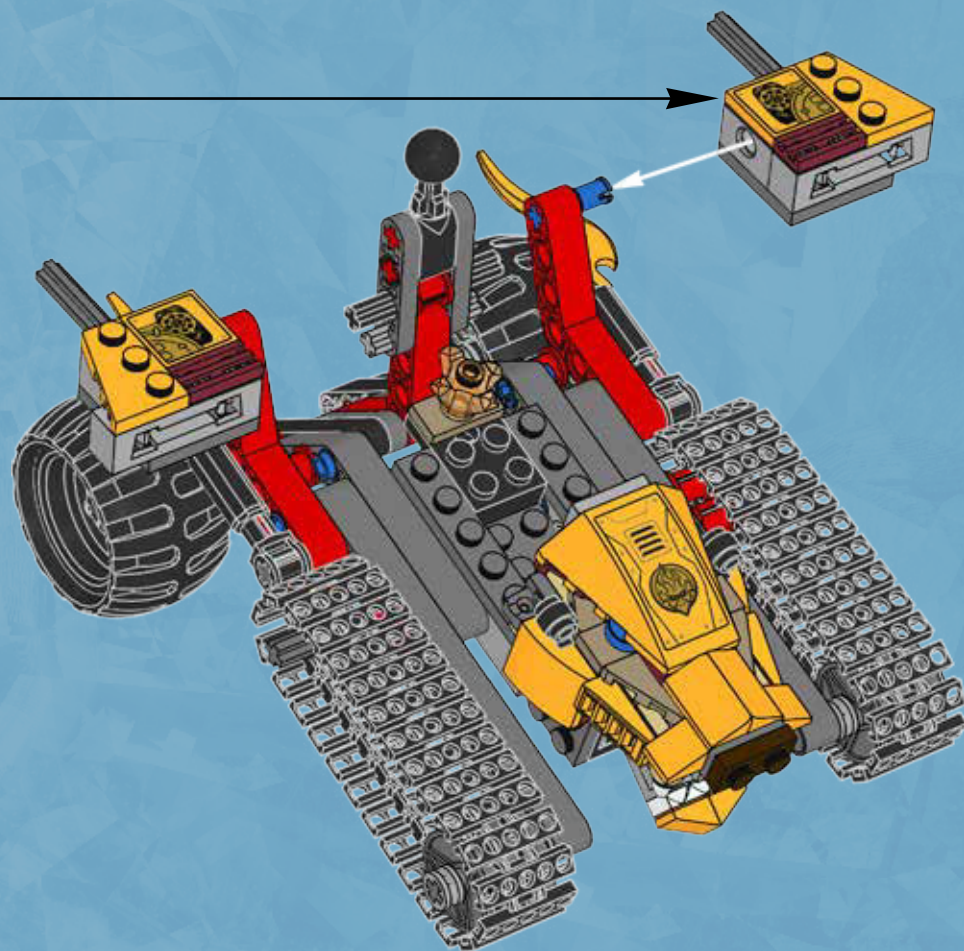
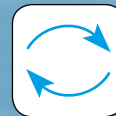



2x

36

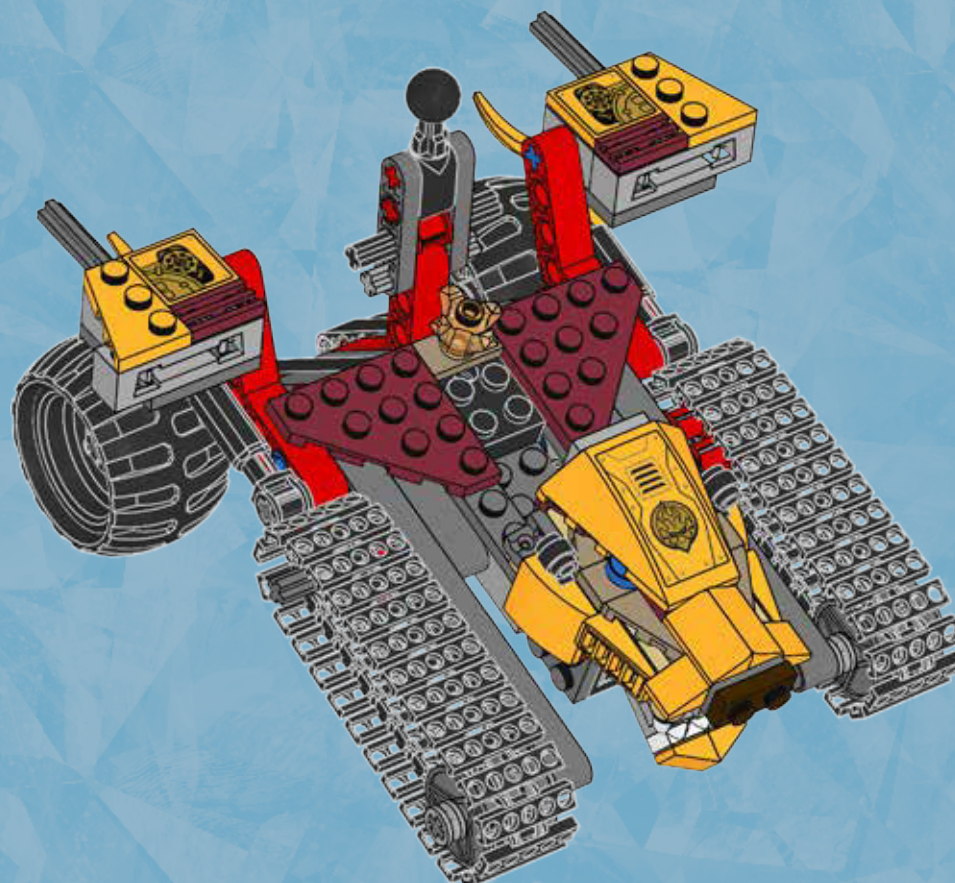

2x

2x

37

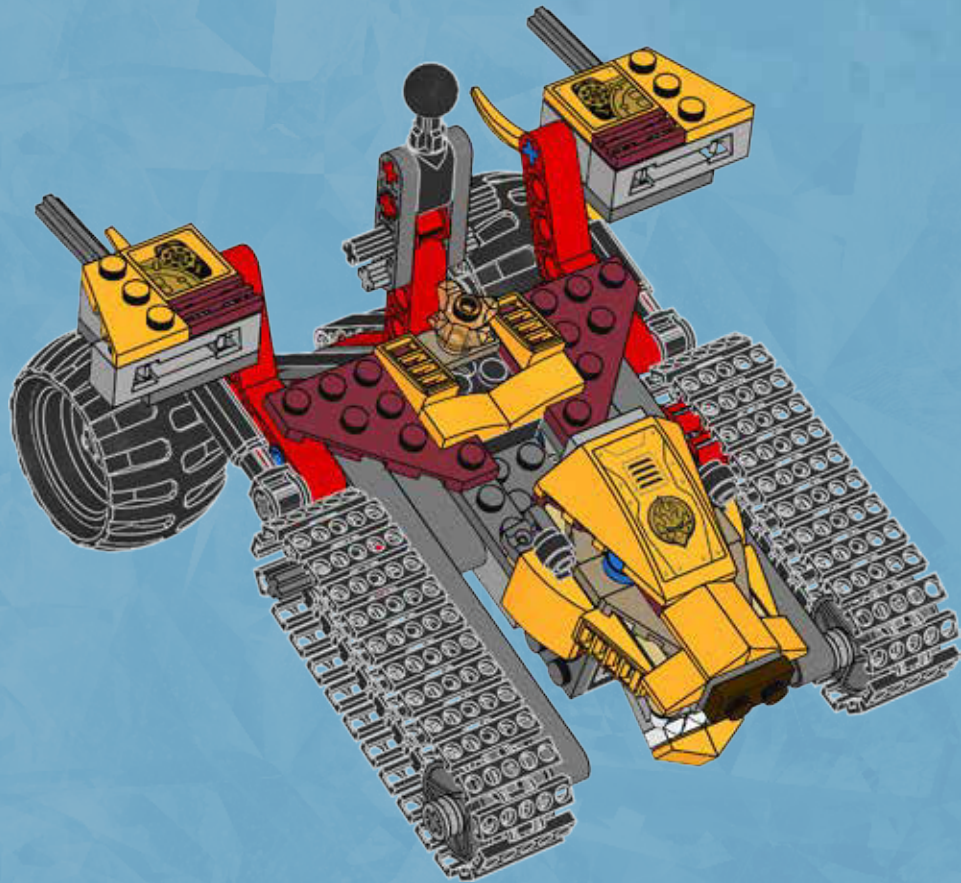

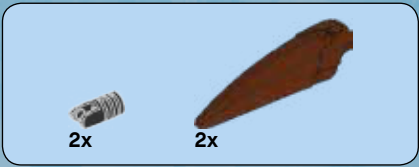

38

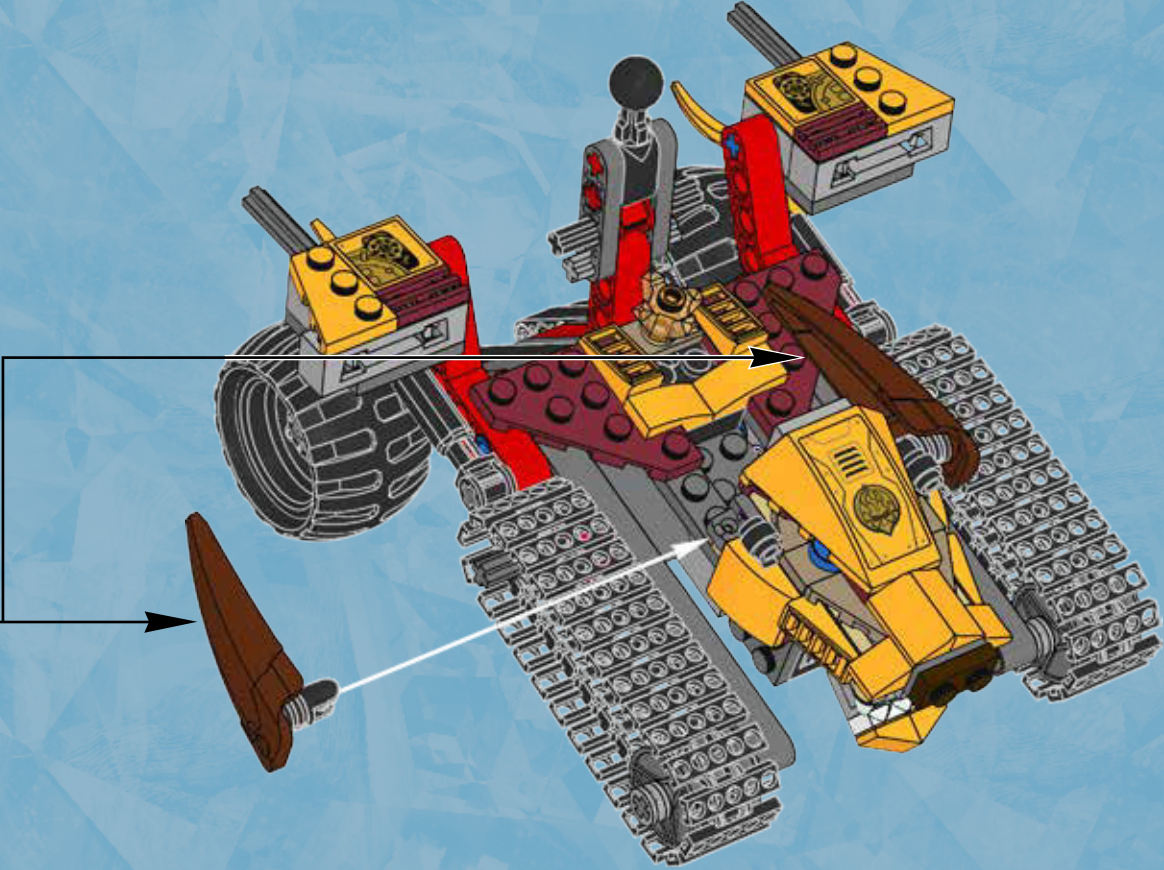
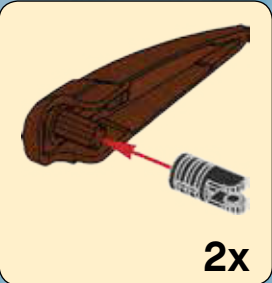



39

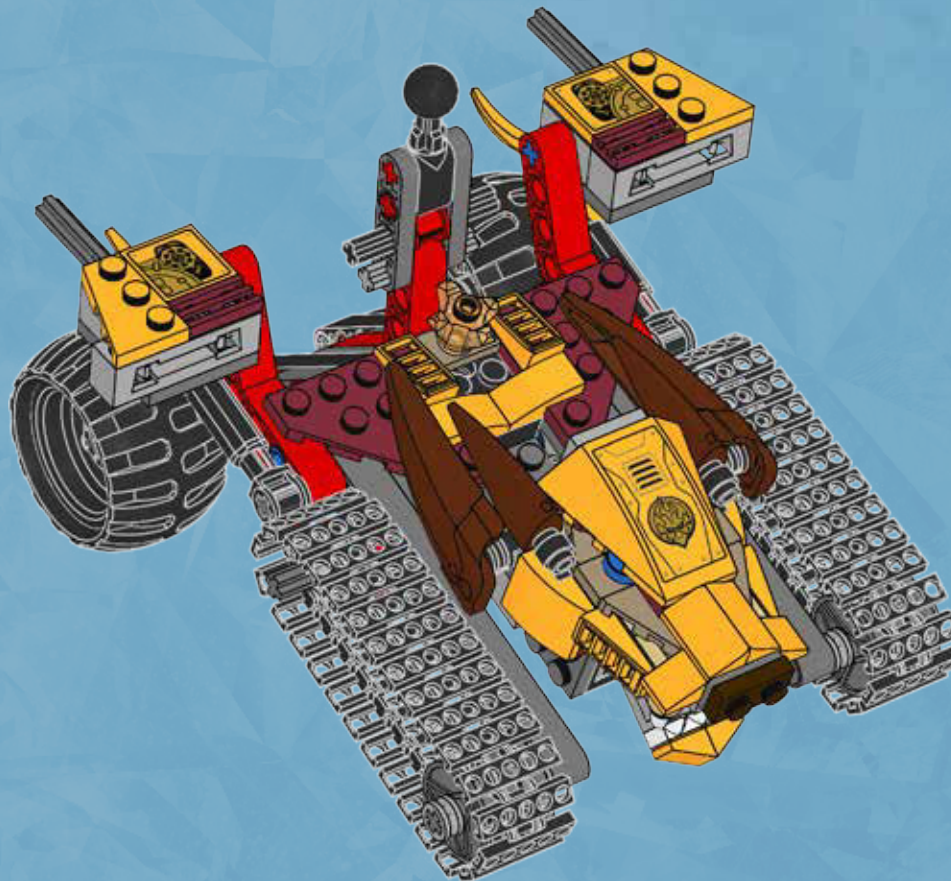



2x

40

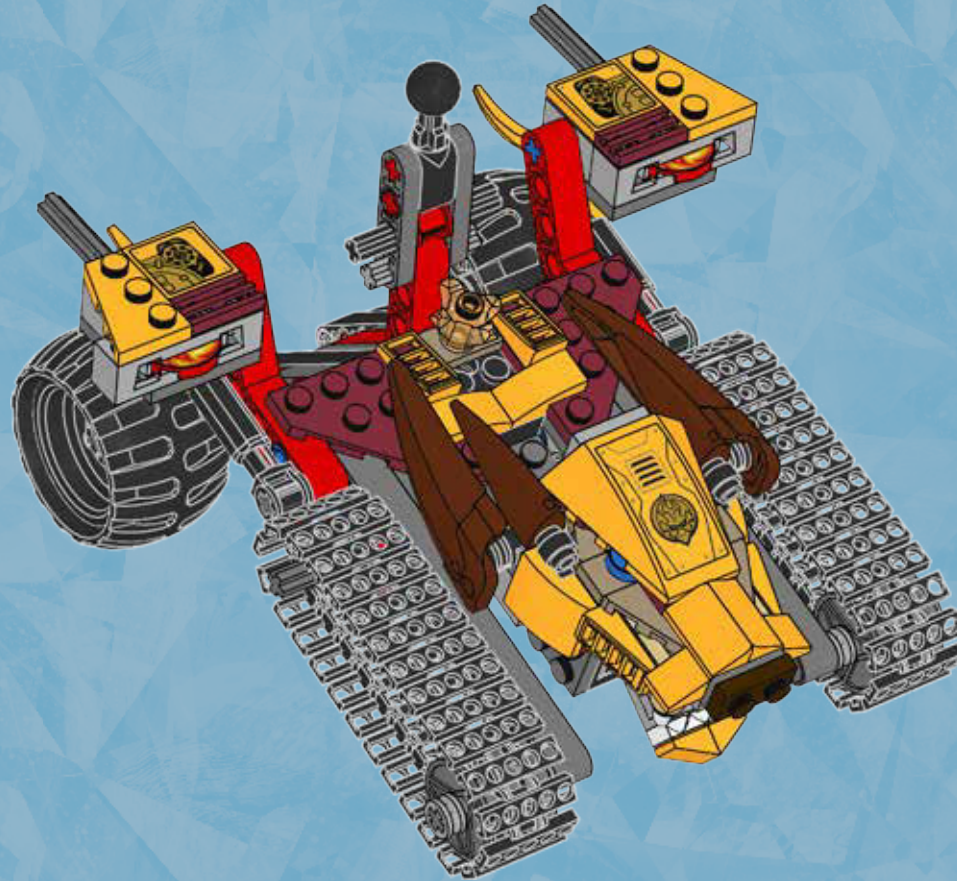

41

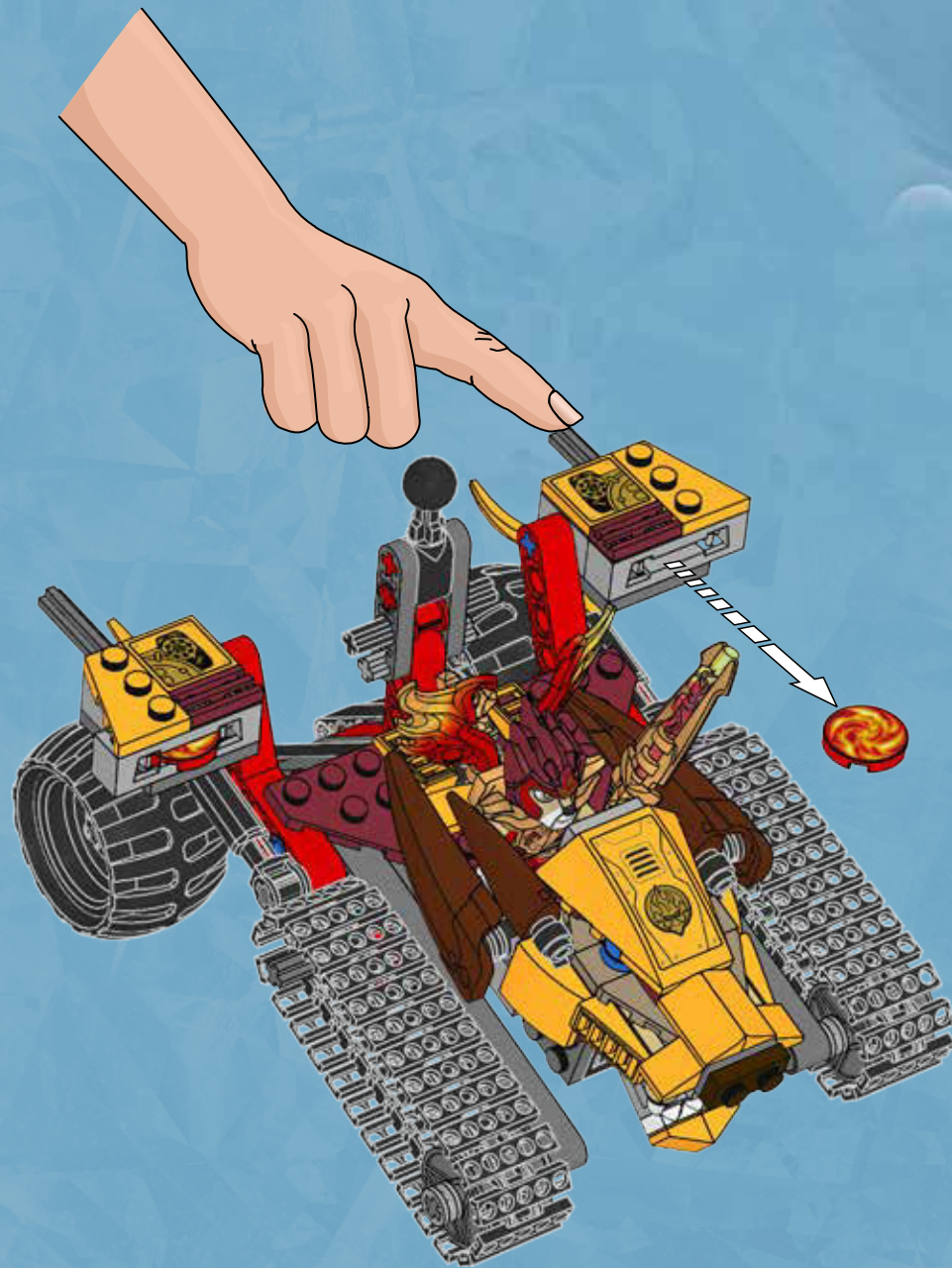

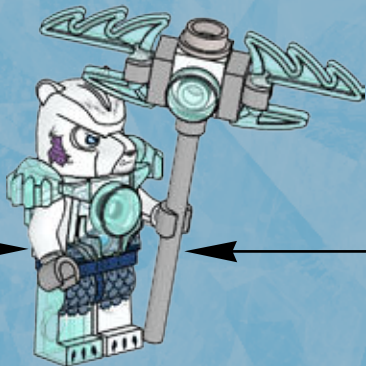
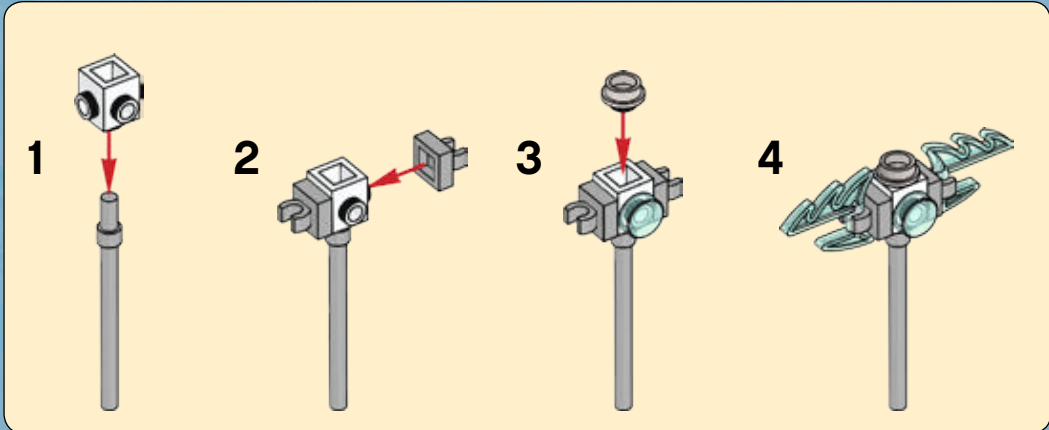
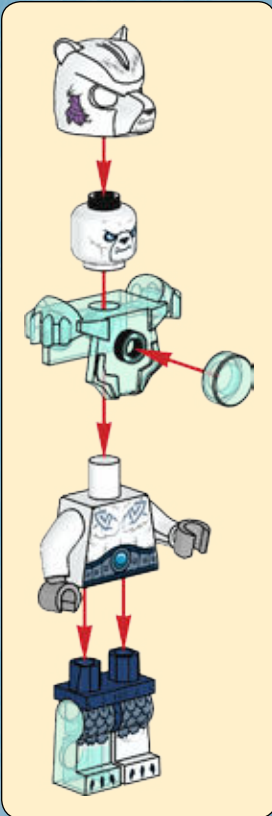
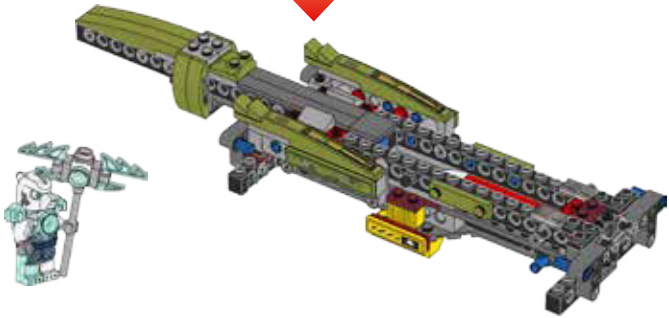
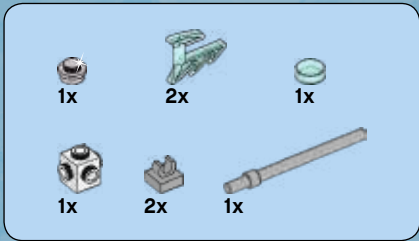
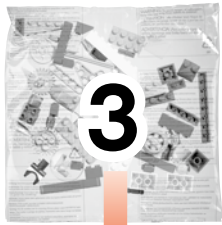

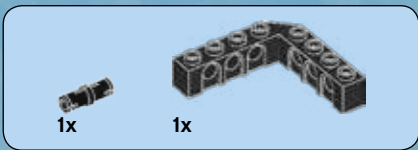
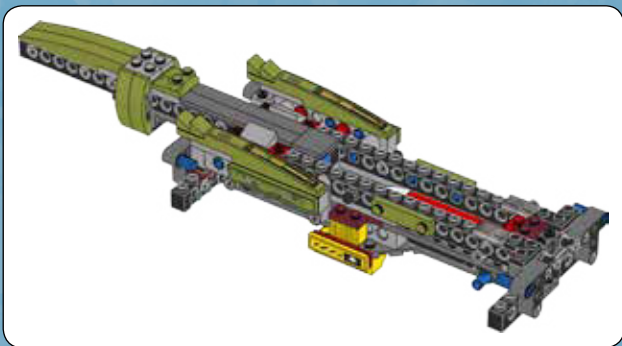

1



2

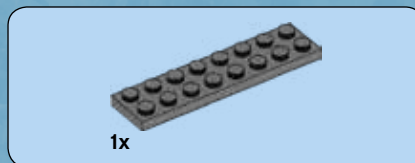

3

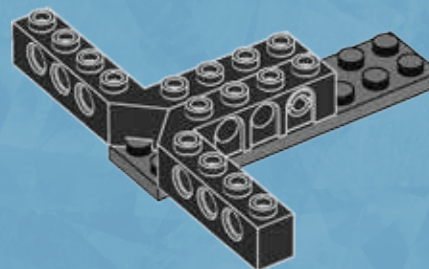

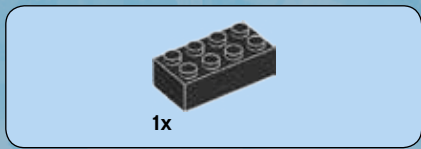

4

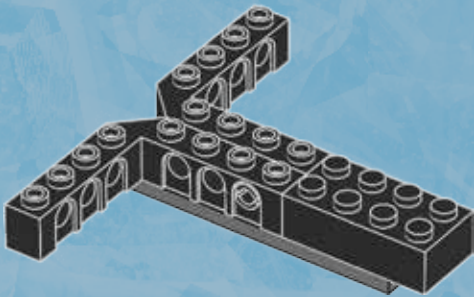

5

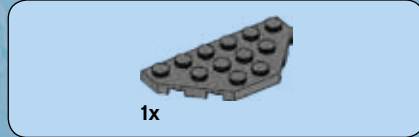
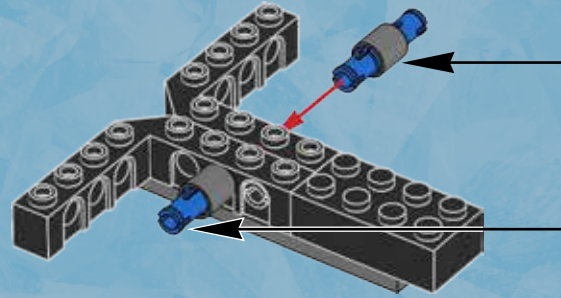
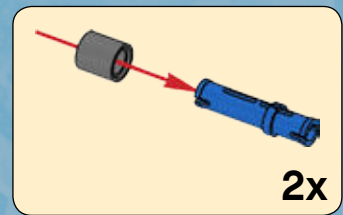

6

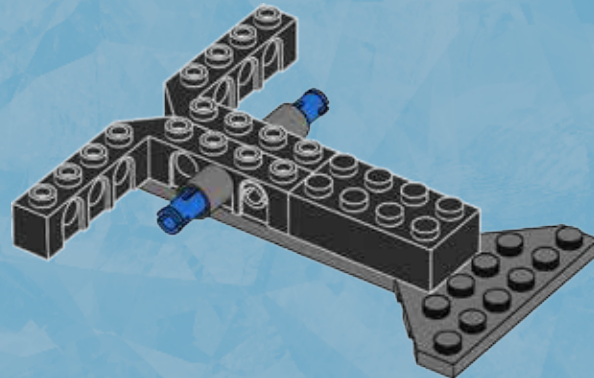



7

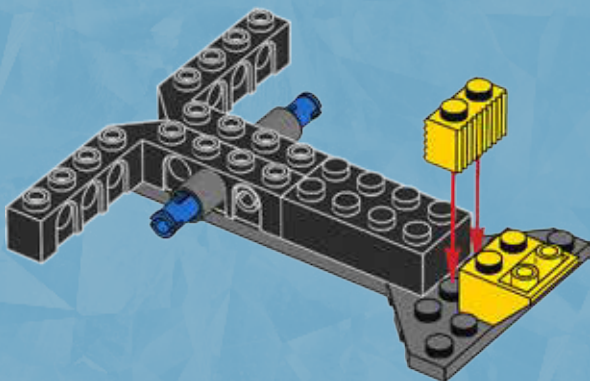

8

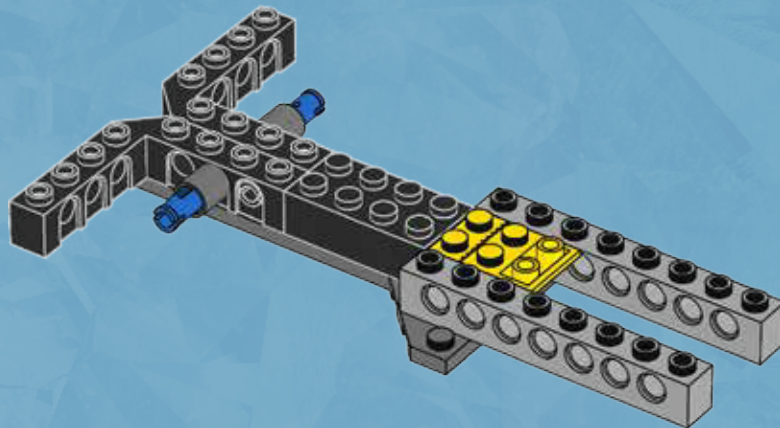

9

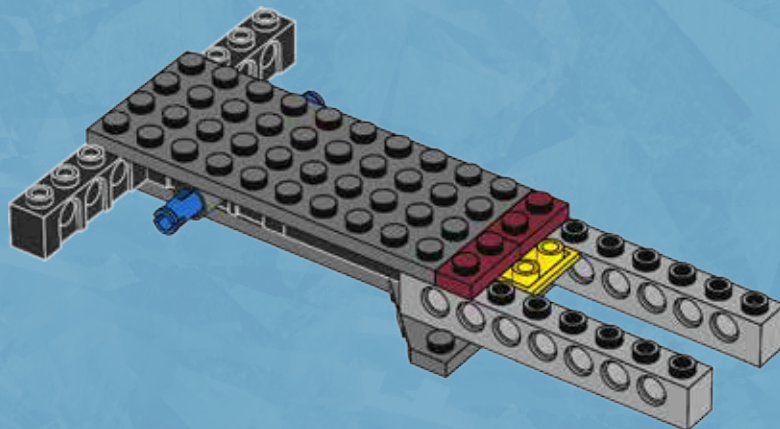

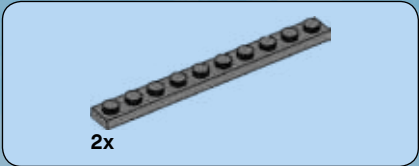

10

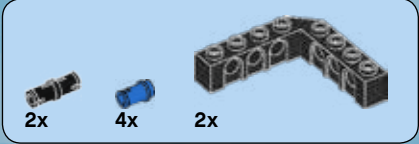
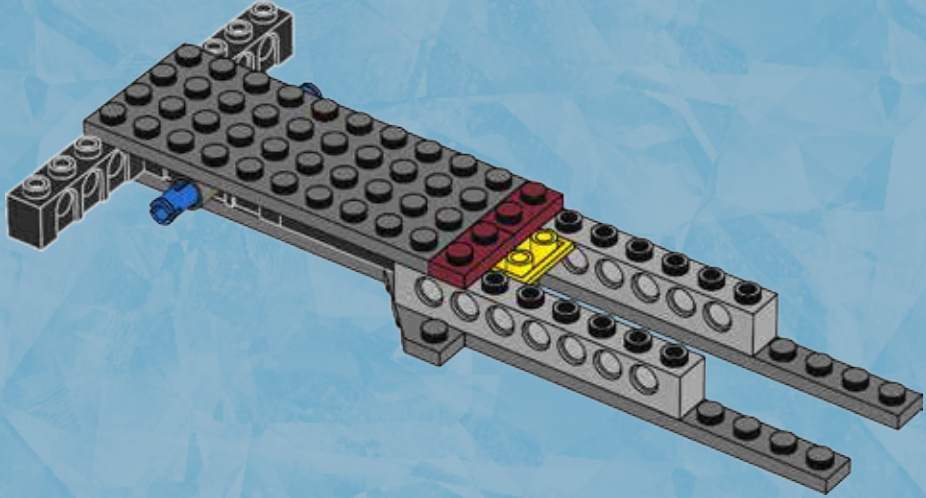

11

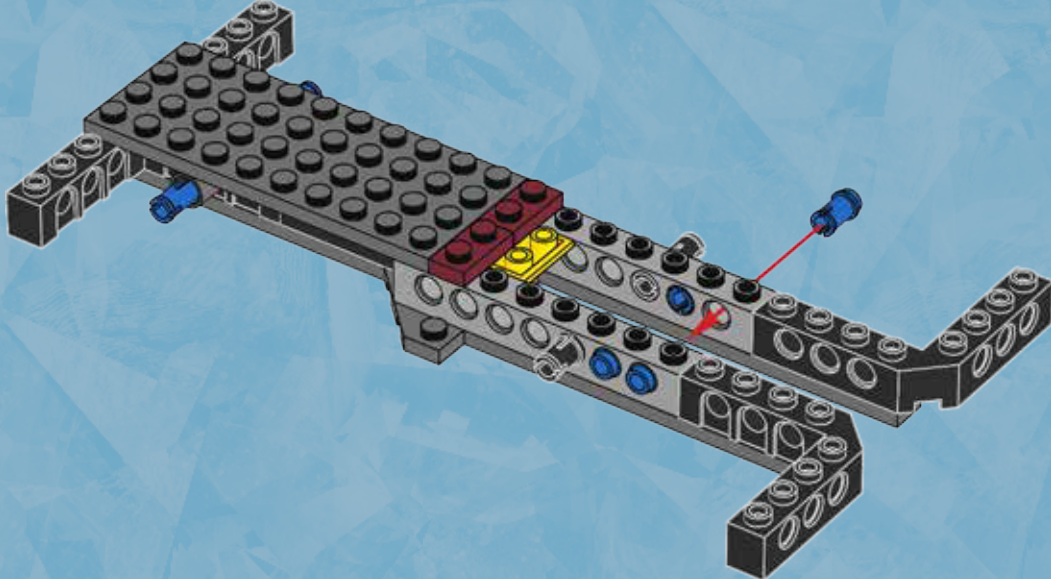

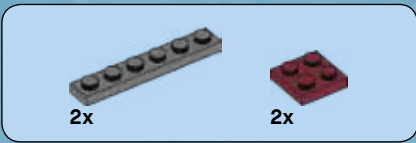

12

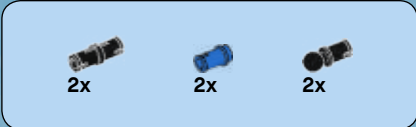
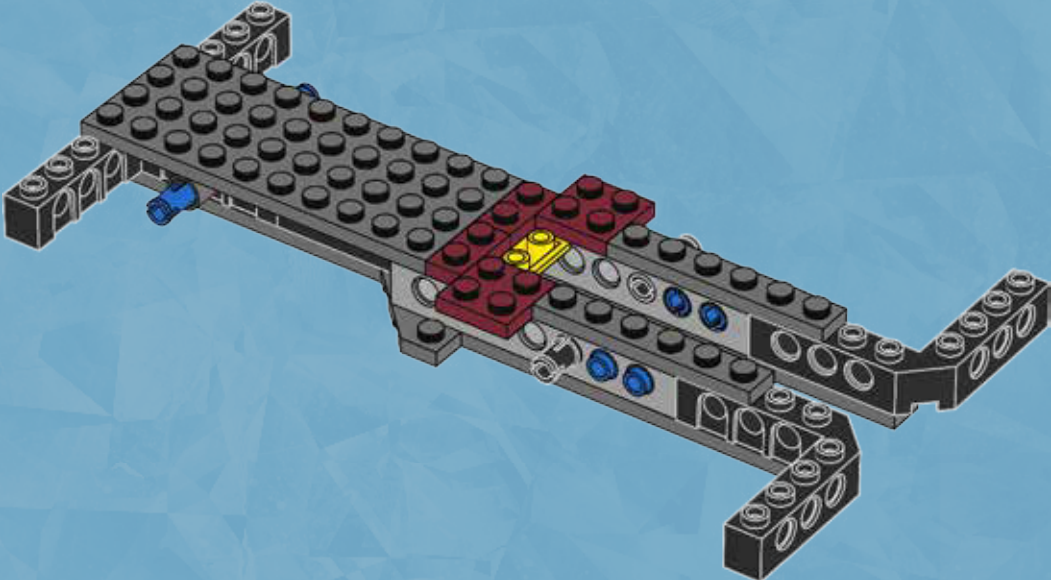

13

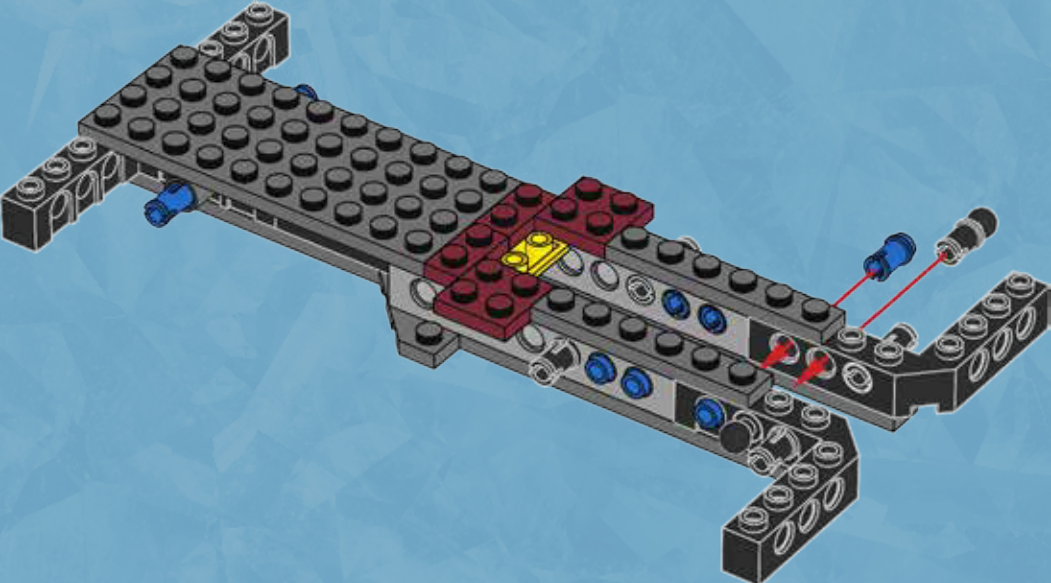

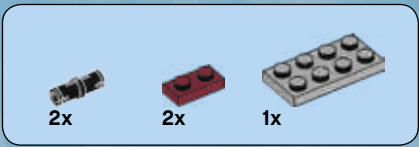

14

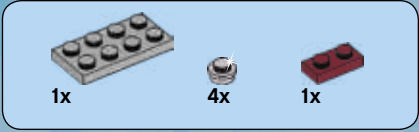
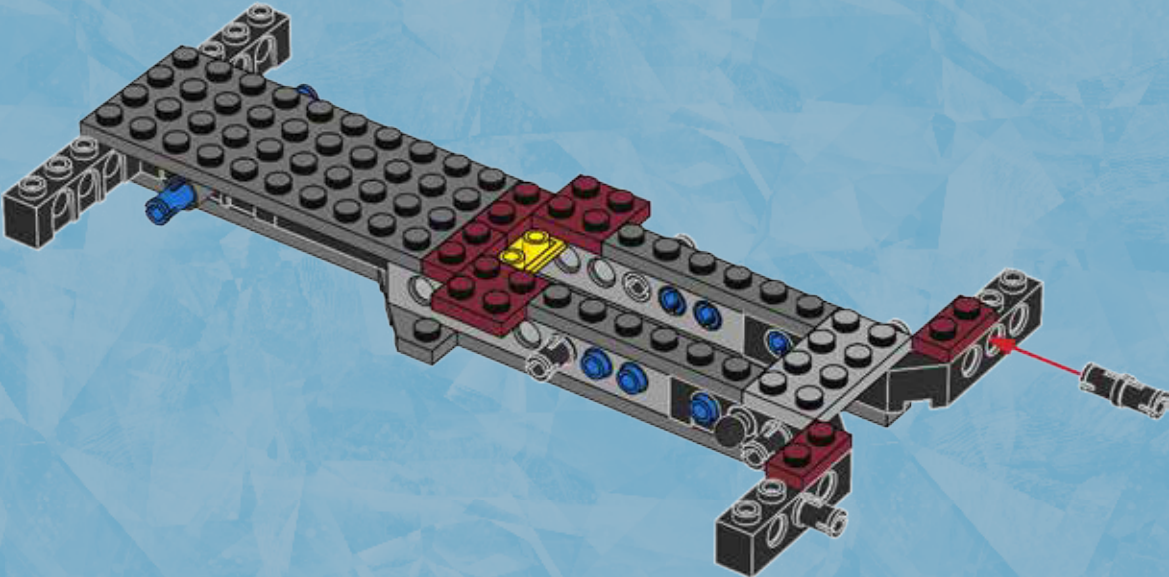

15

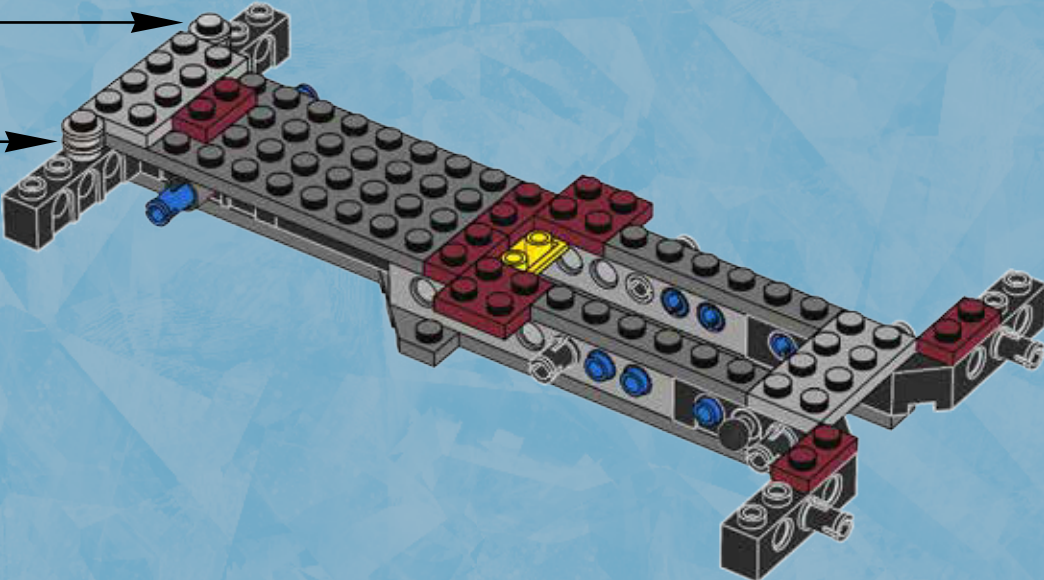
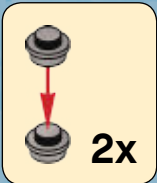



16

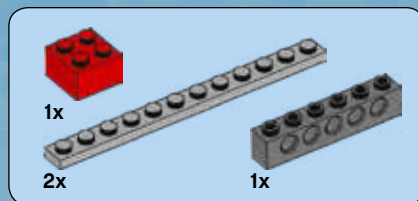
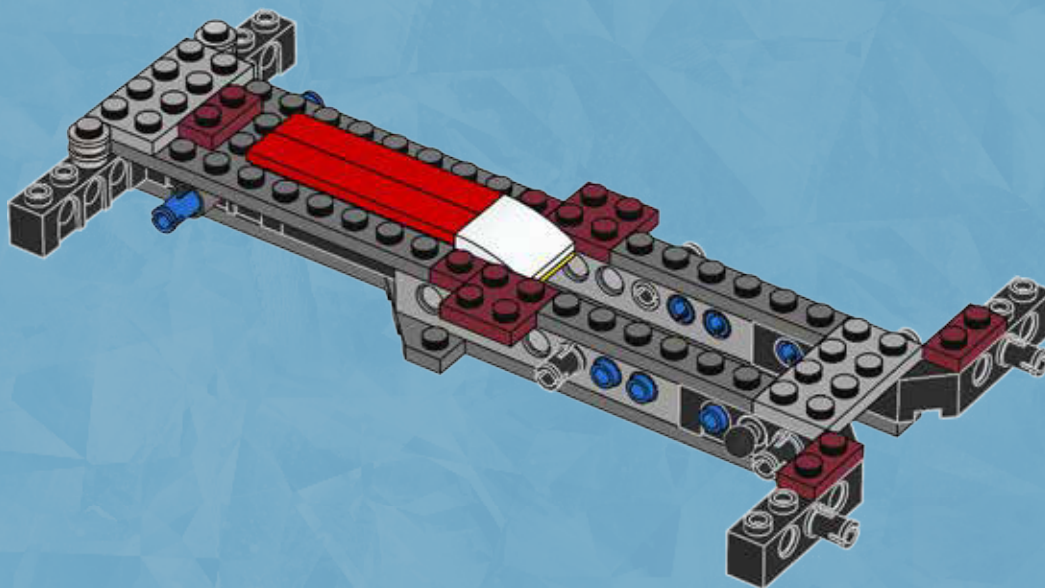

17

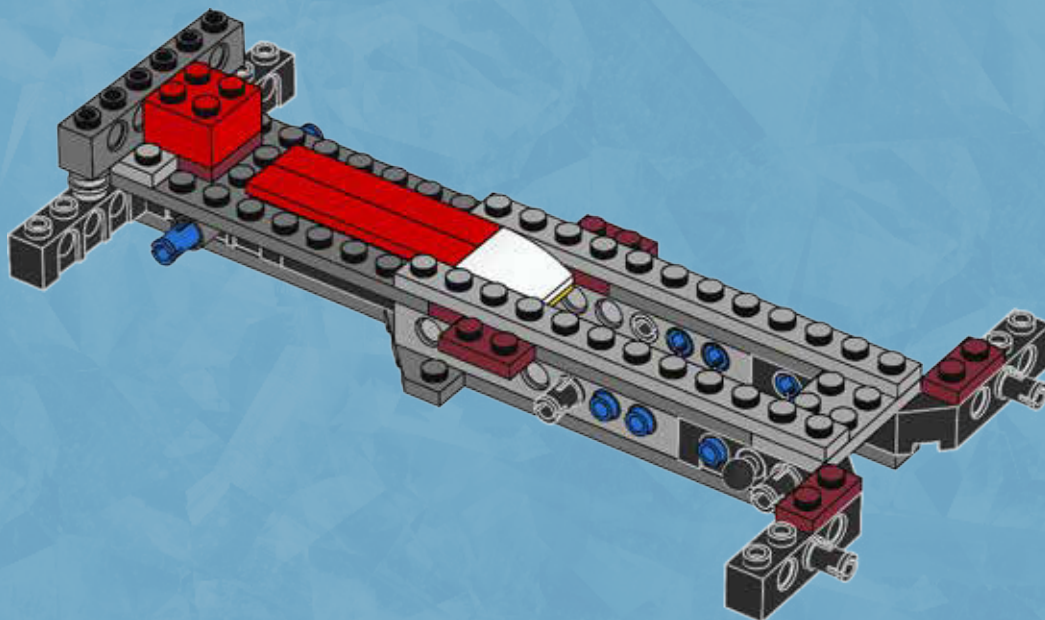

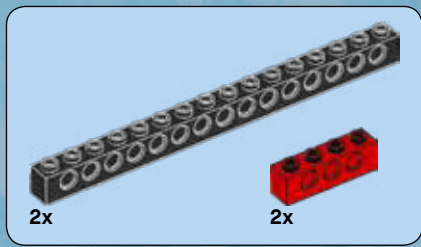

18

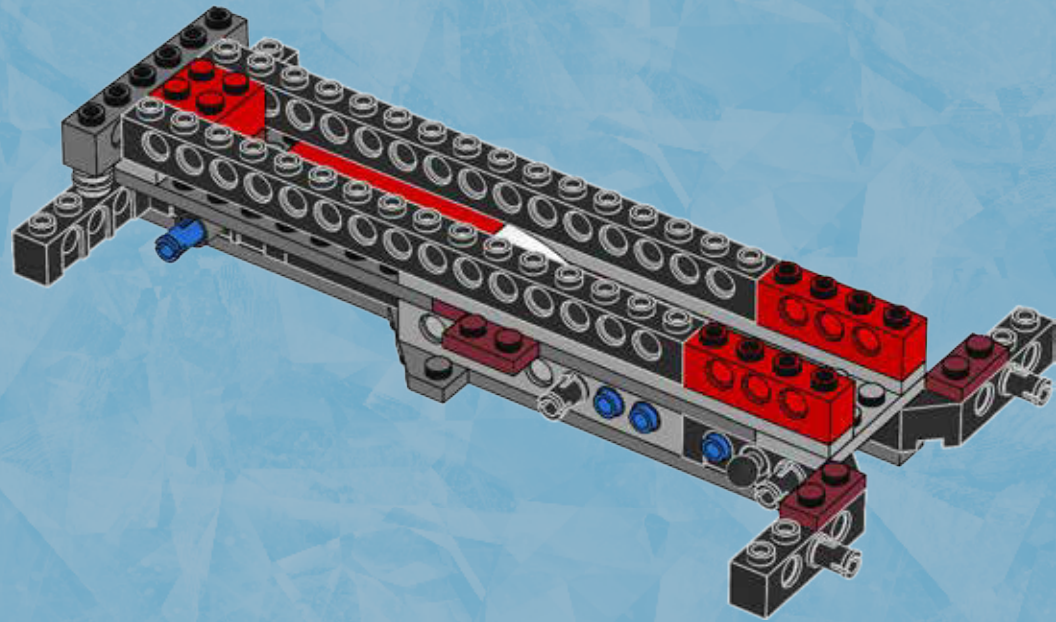

19

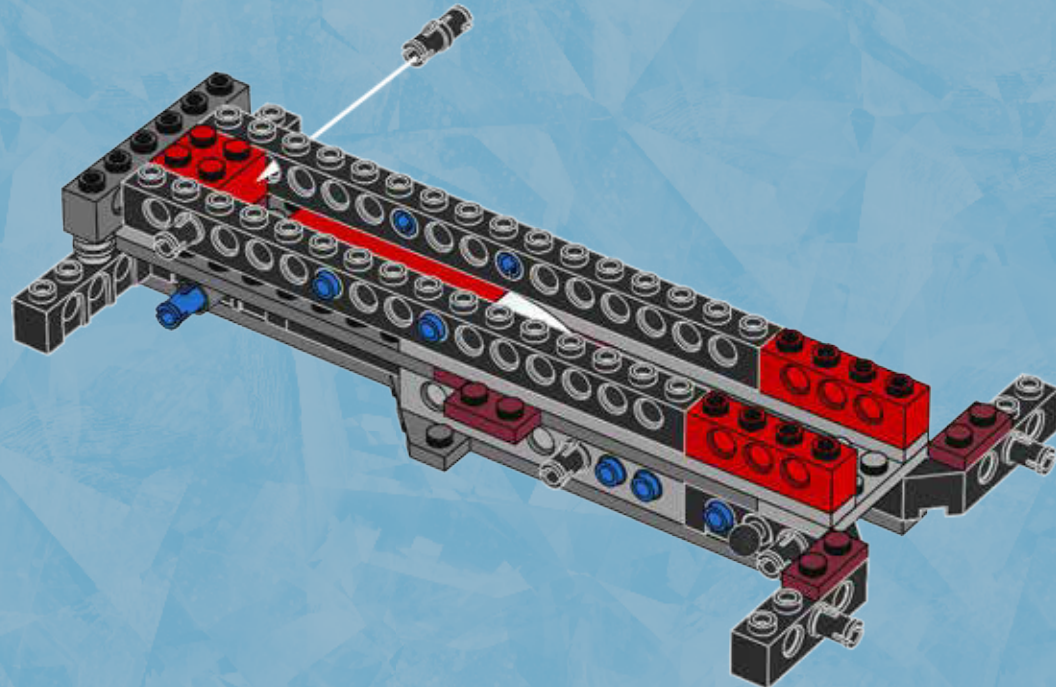

2x



4x

20

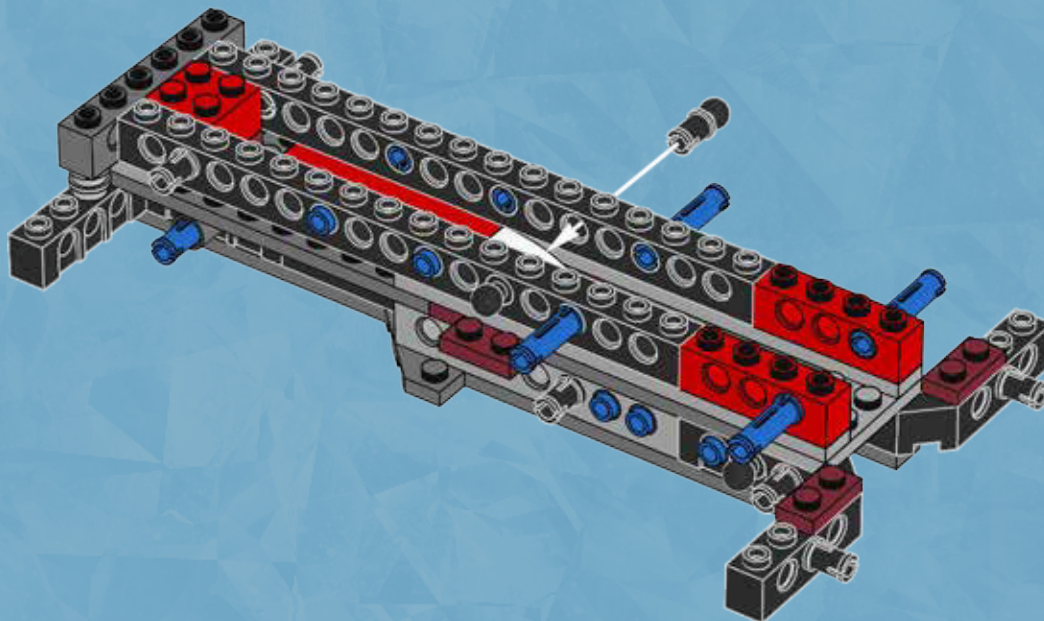

4x



2x

21

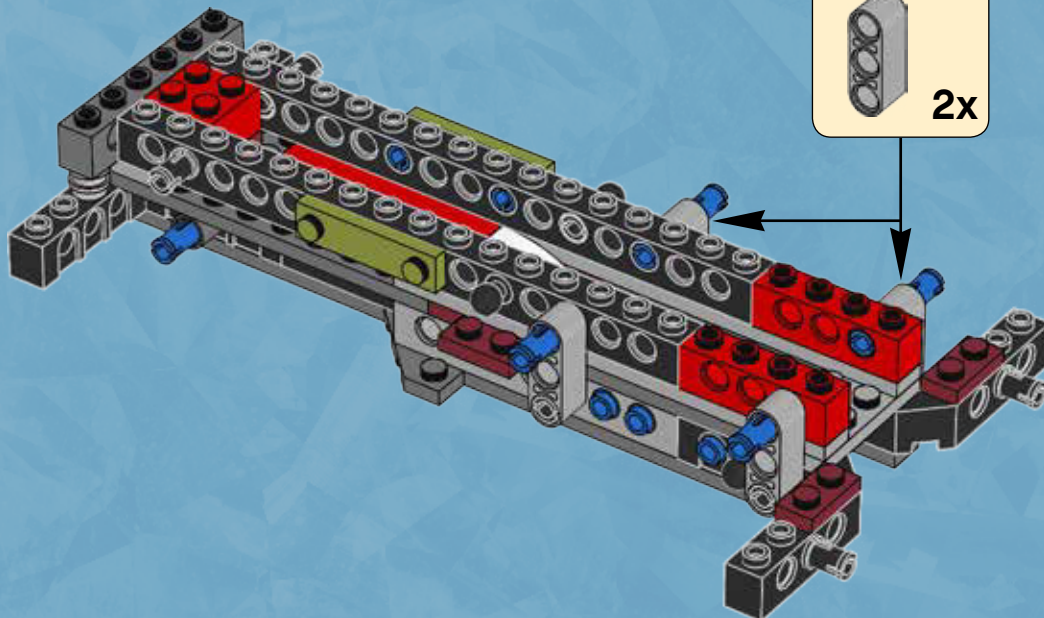

2x



4x

22

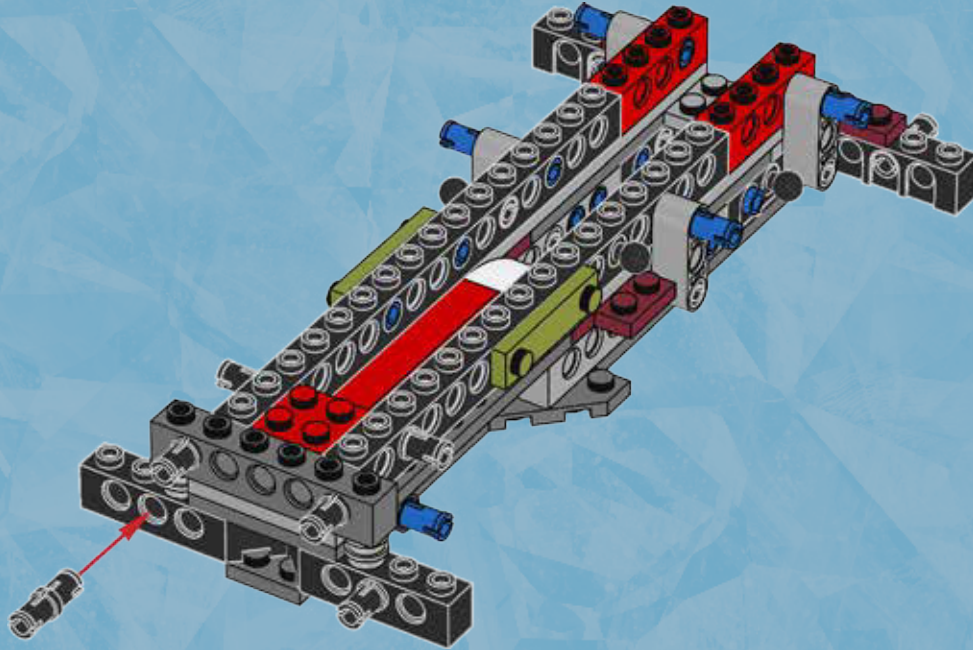



23

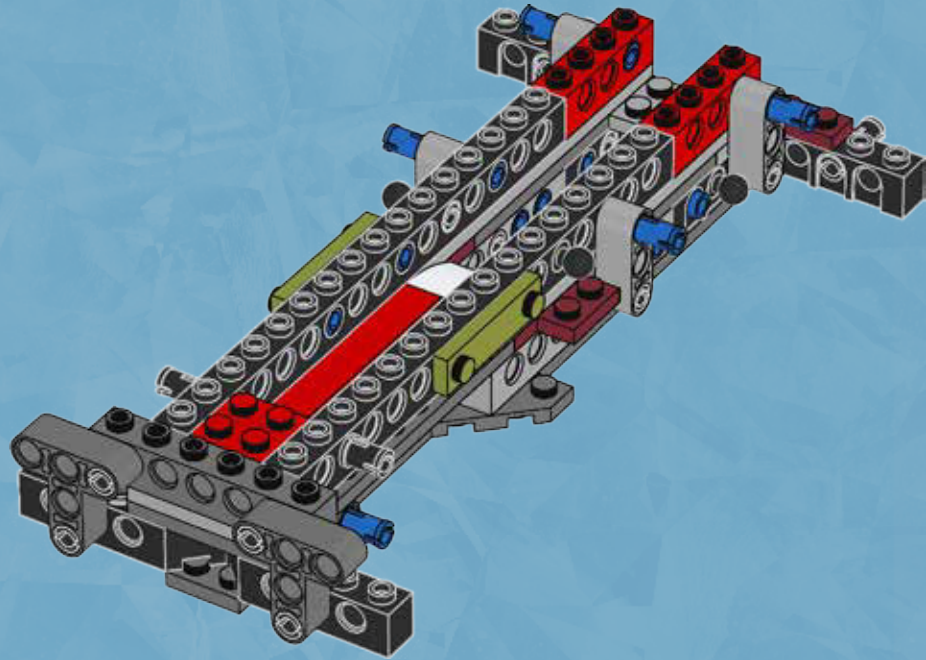

24

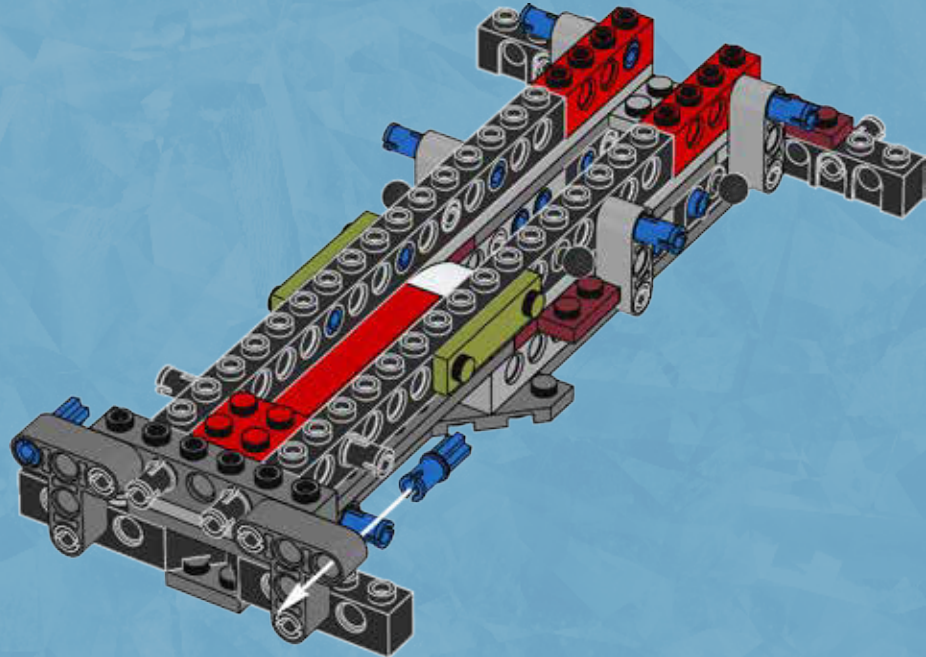

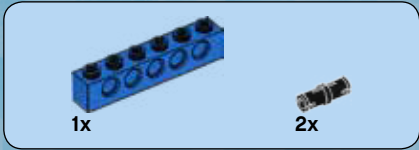
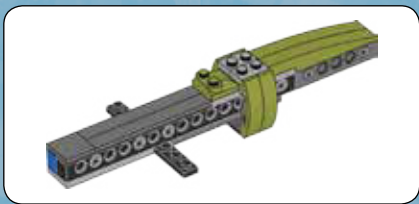

1

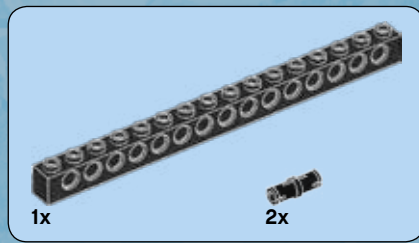
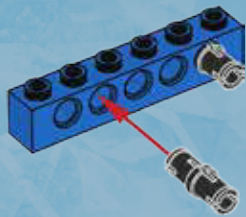

2

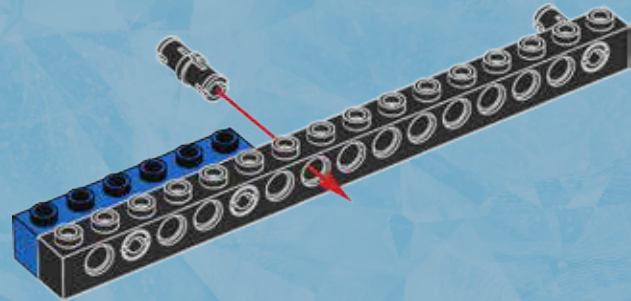

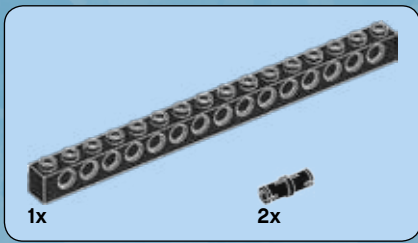

3

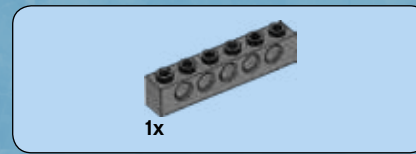
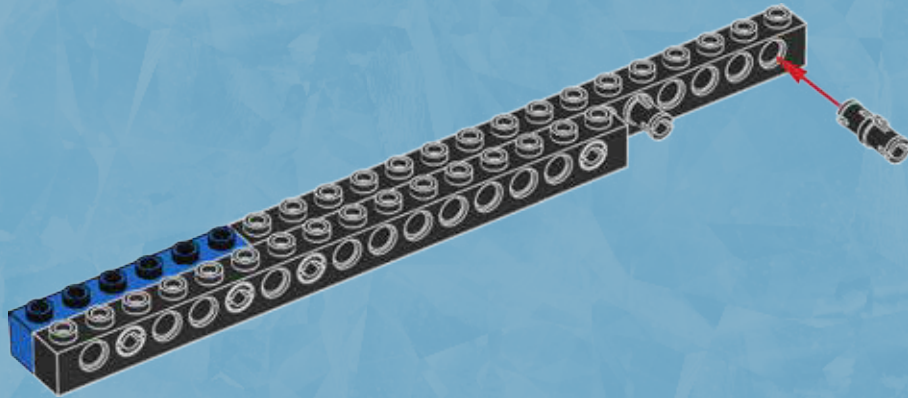

4

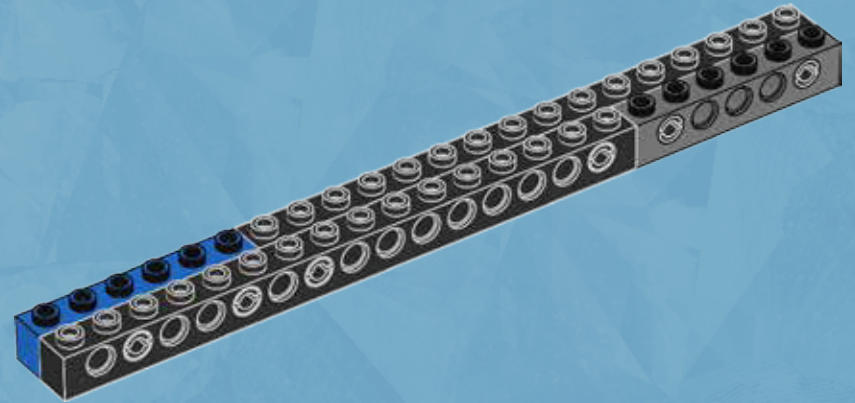

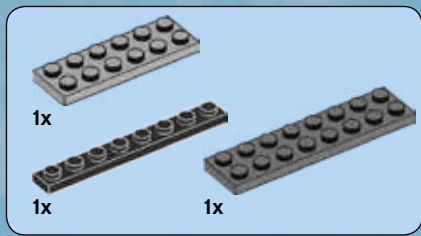

5

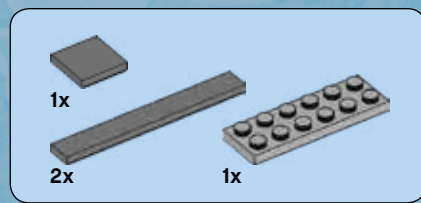
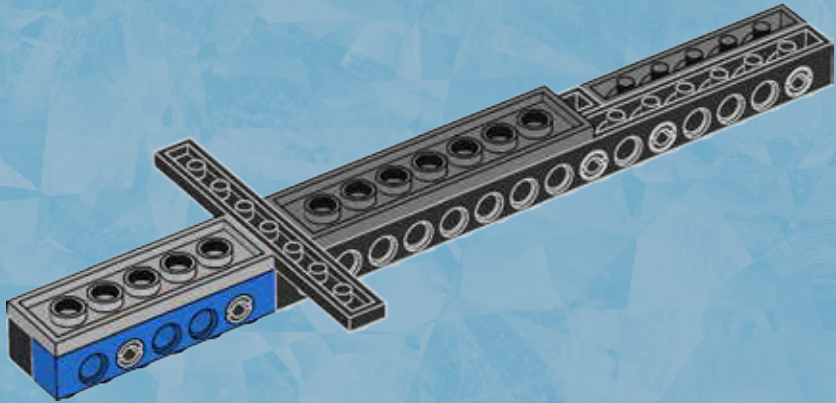

6

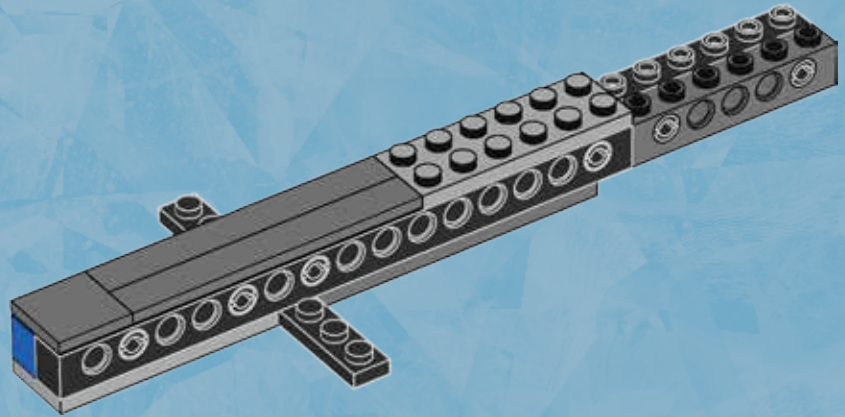

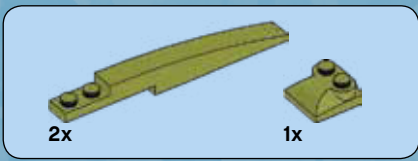

7

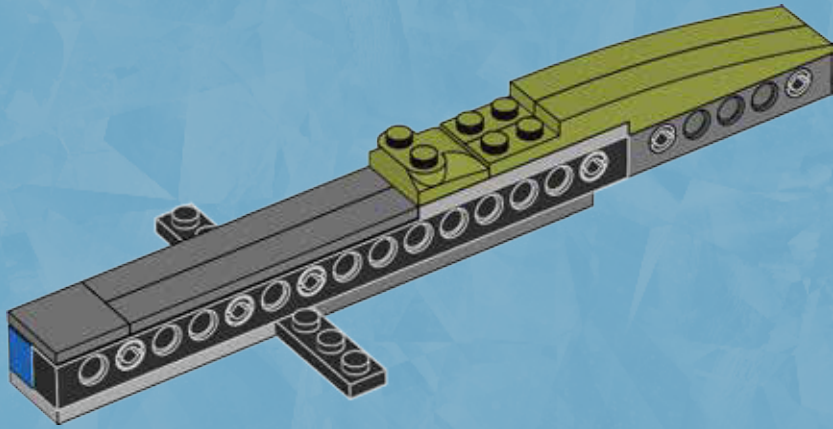

8

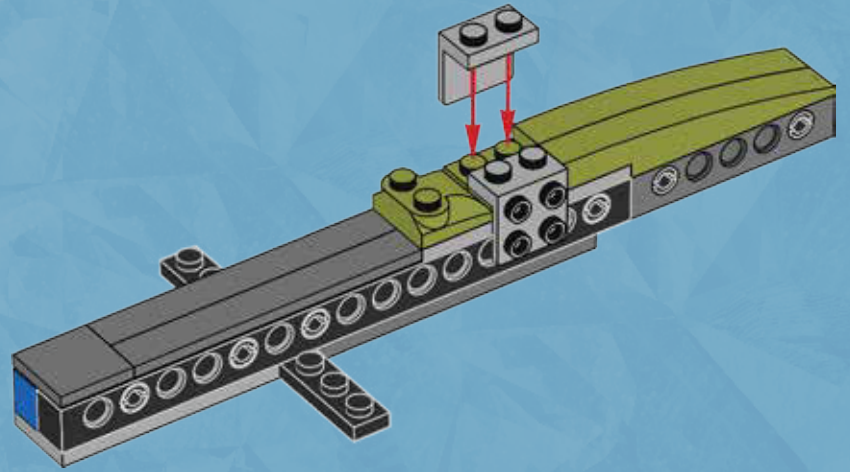



2x



2x

9

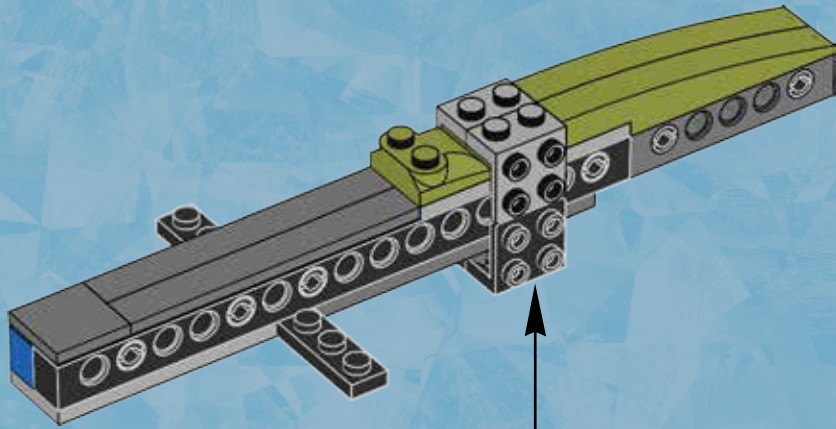

1



2



2x



4x

10

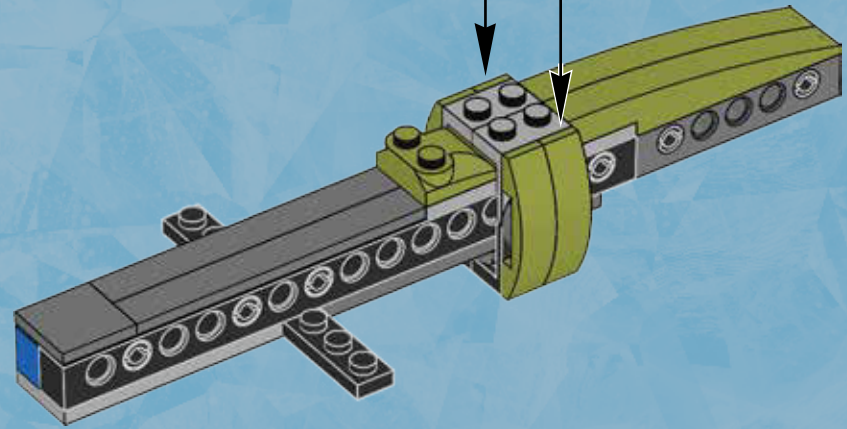

1



2

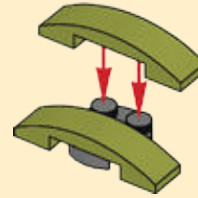

2x

25

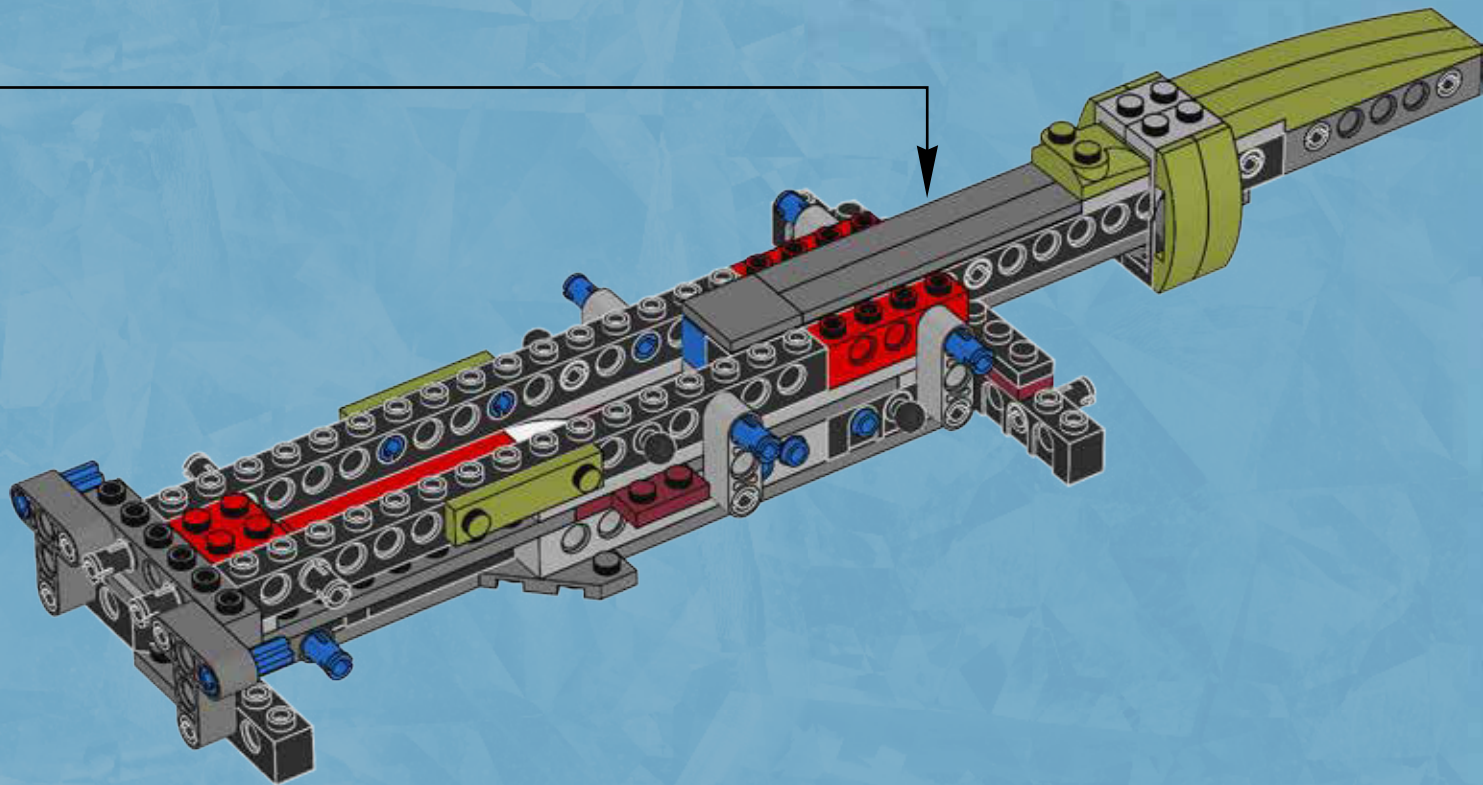



4x



2x

26

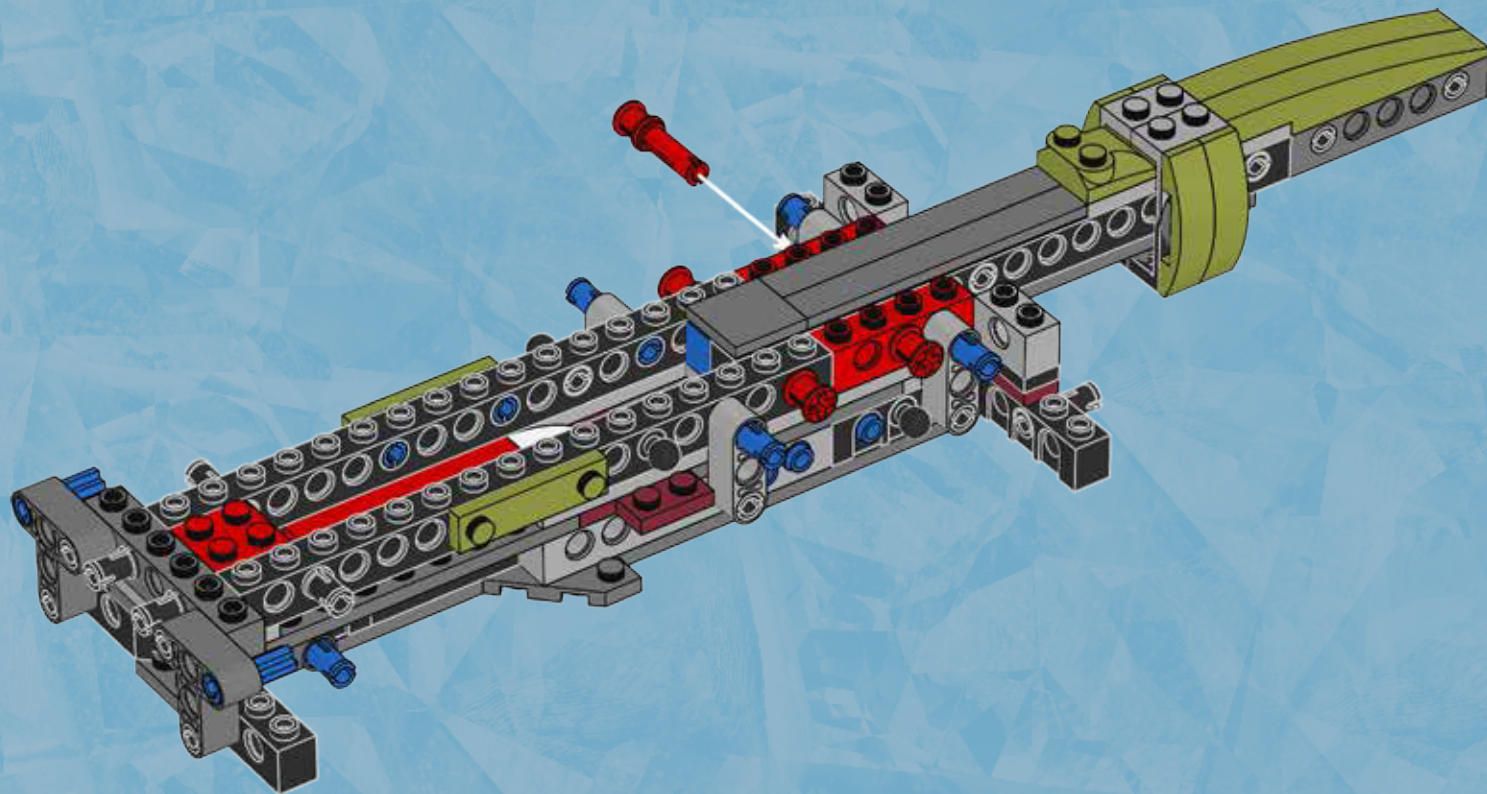



4x

28

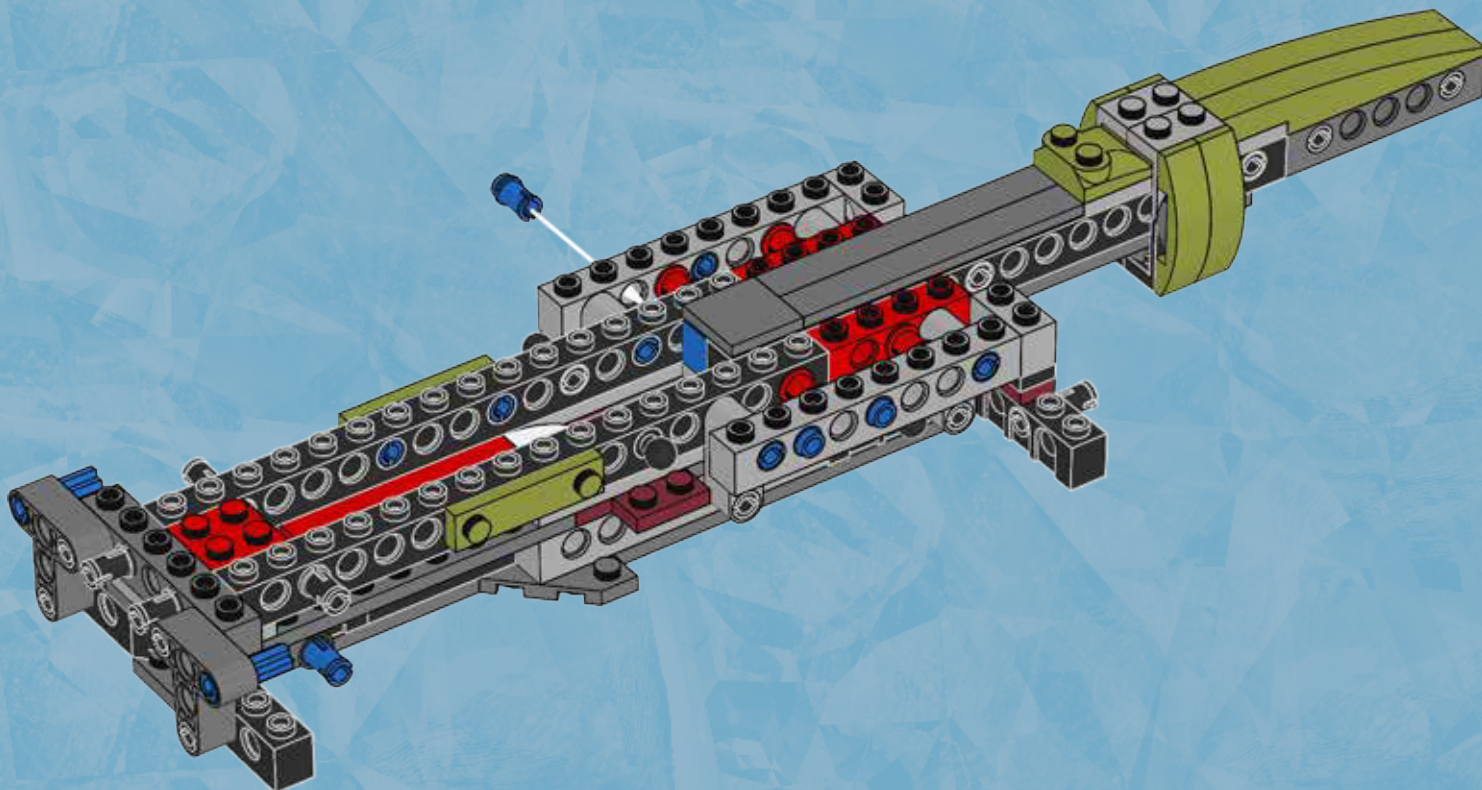

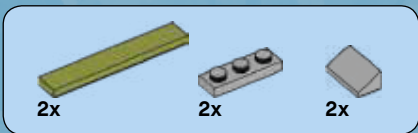

29

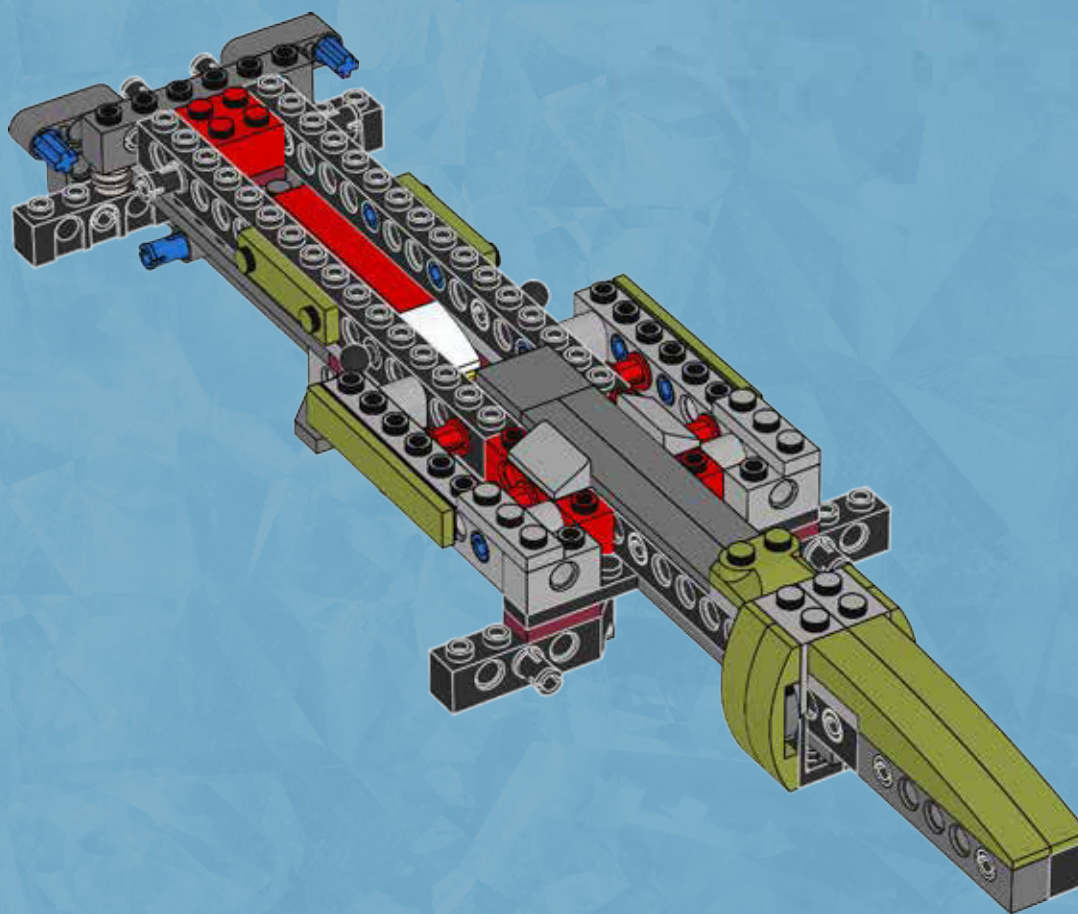



2x

30

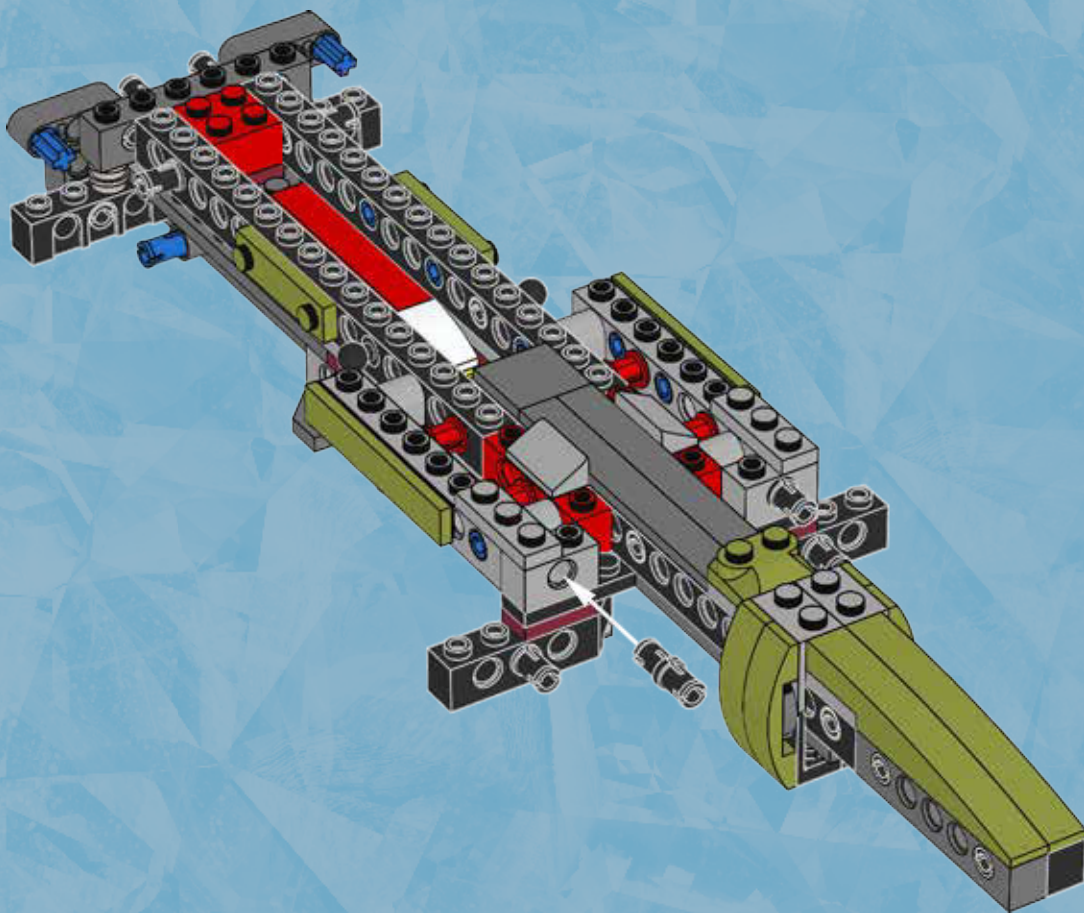



31

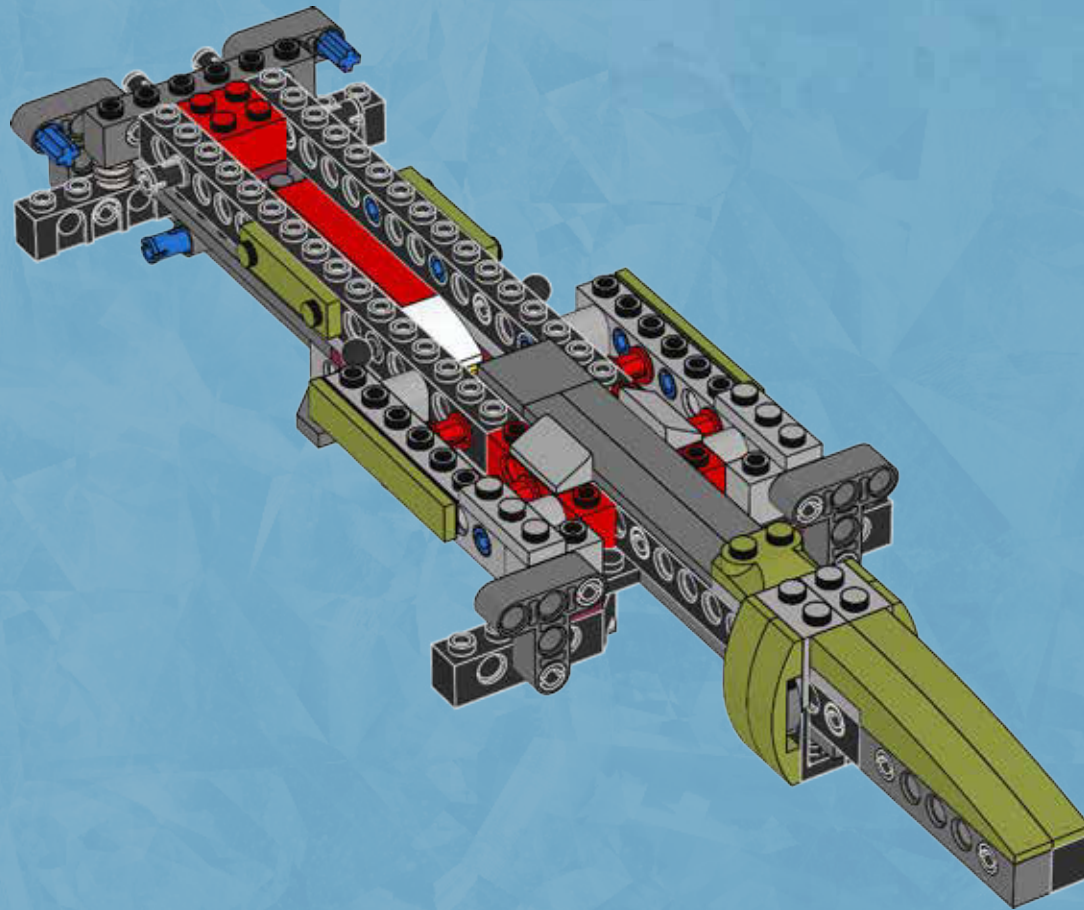



2x

32

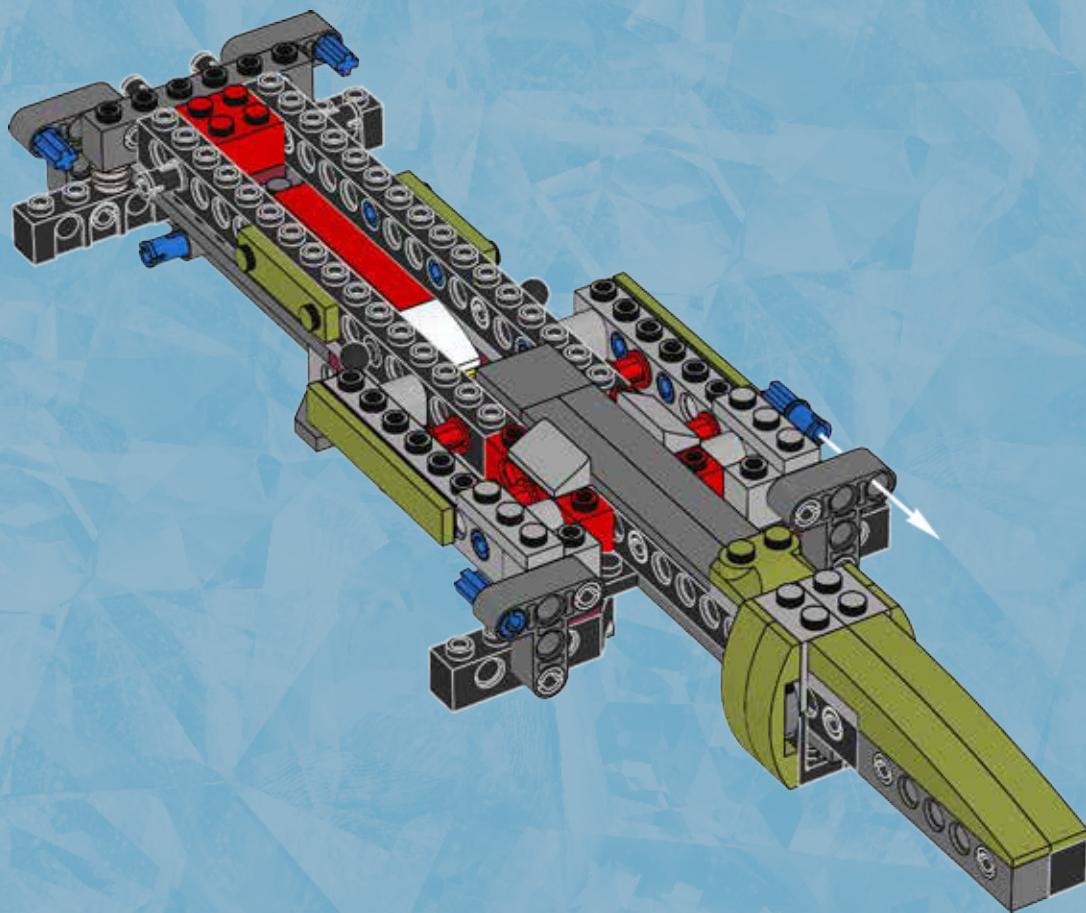

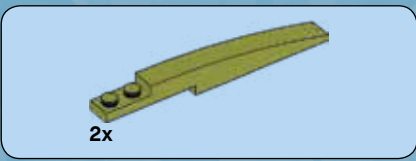

33

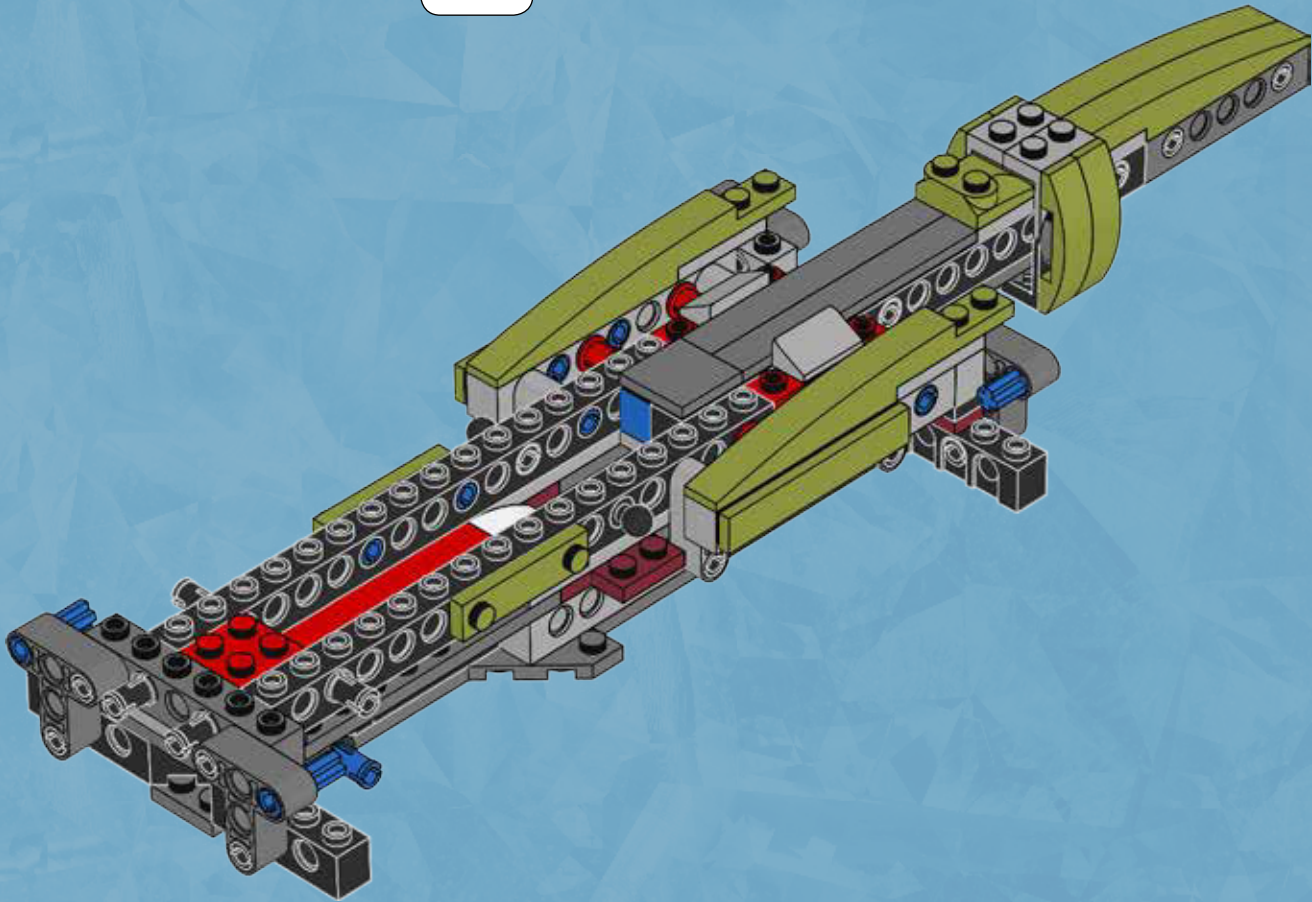



4x

34

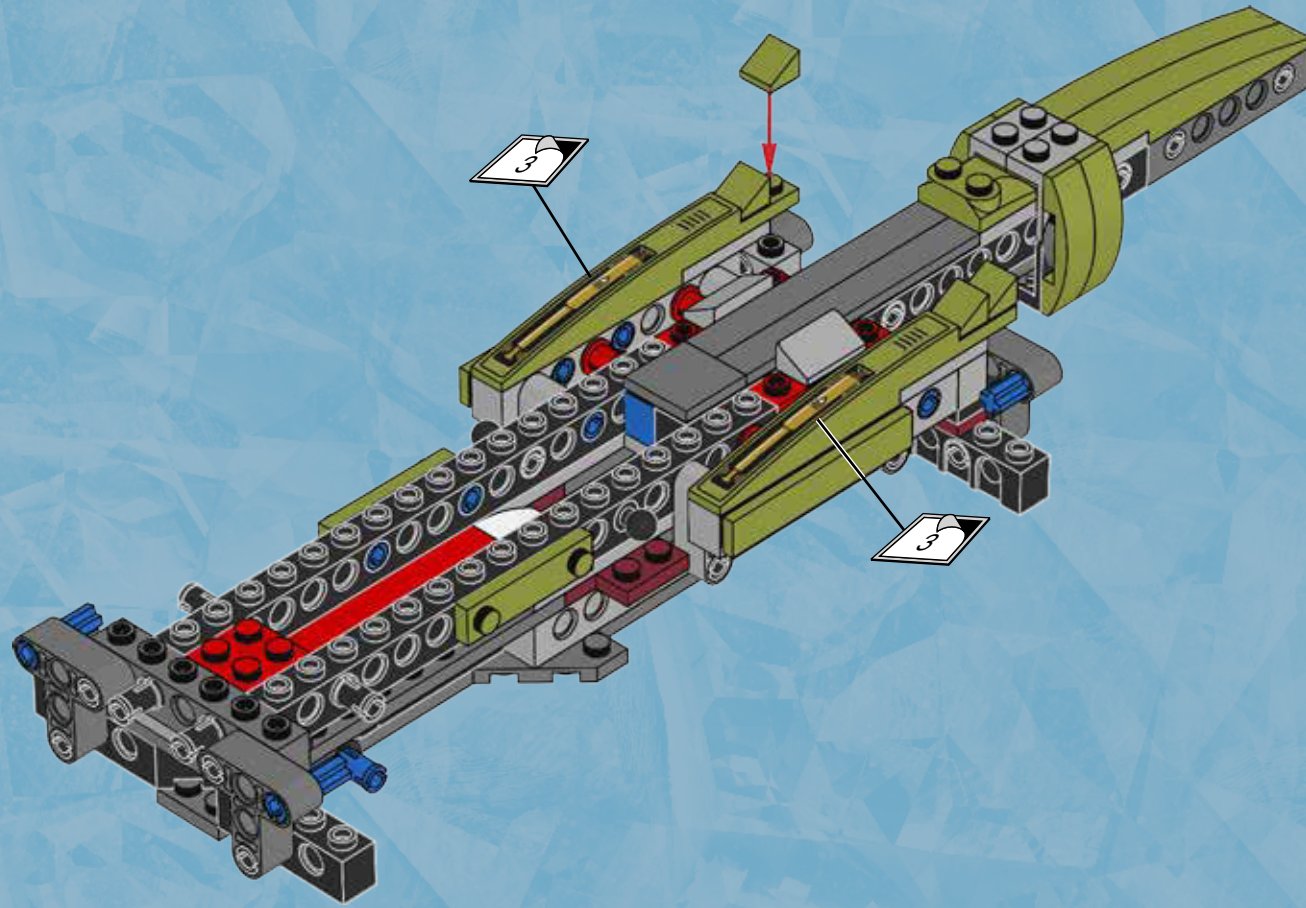



2x

35

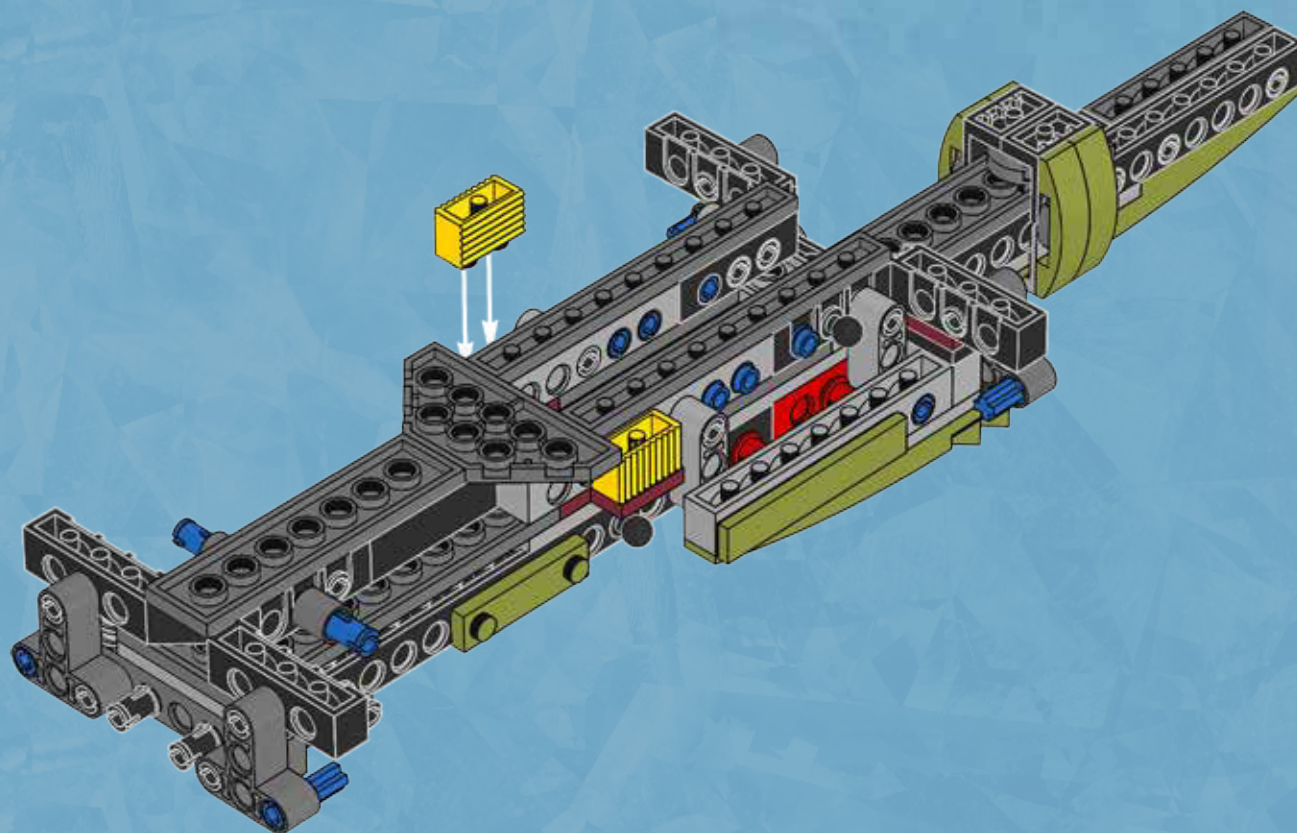



2x



2x

36

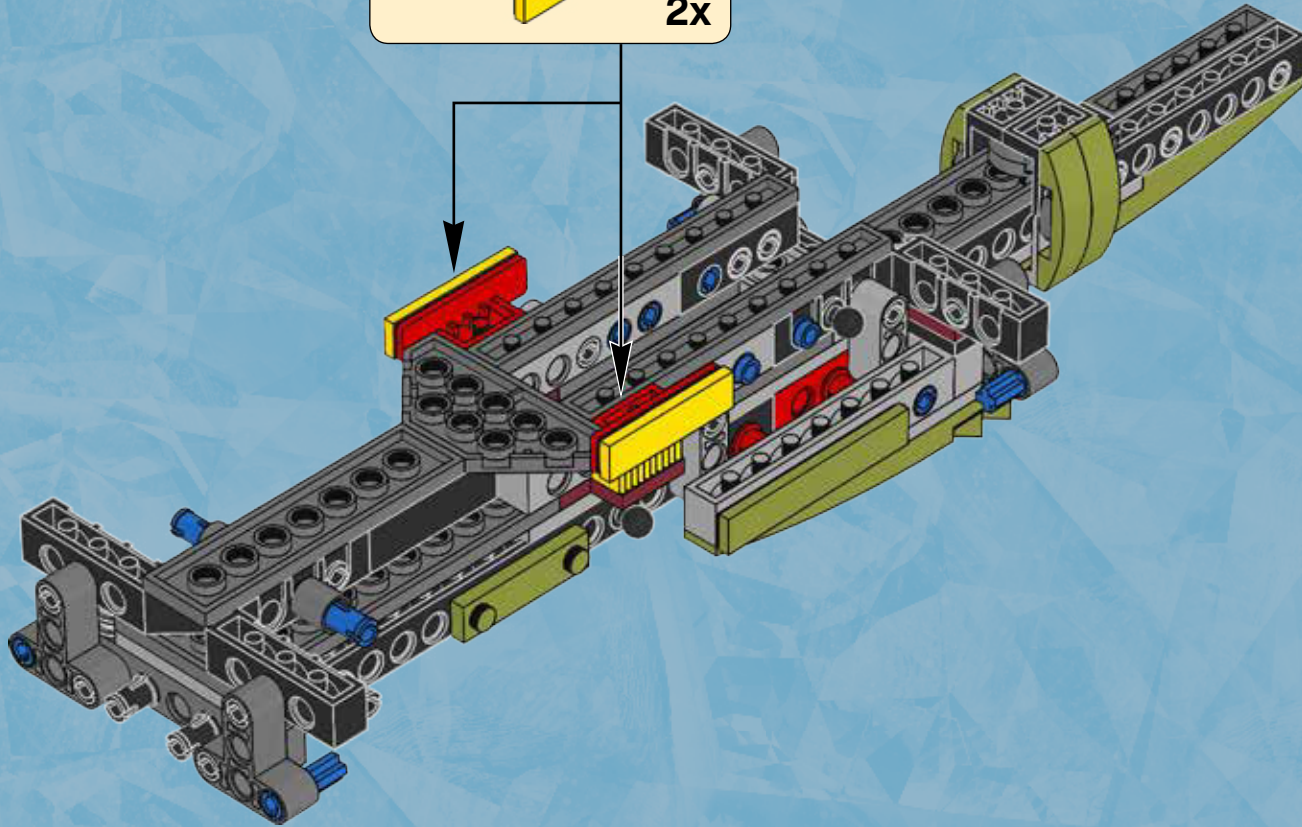
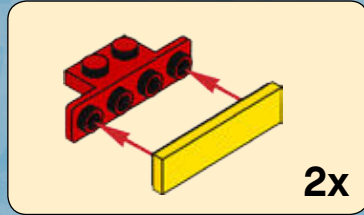



4x

37

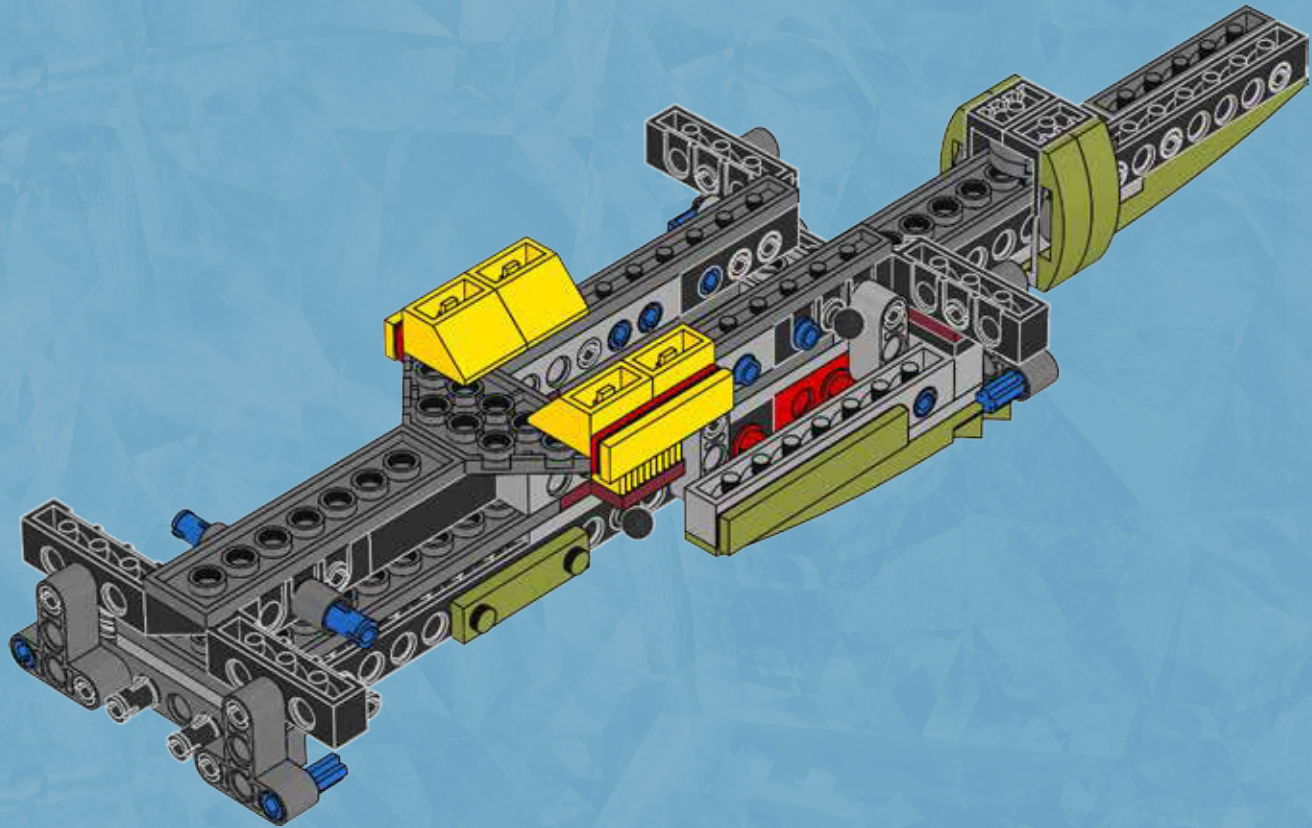

1x 2x 2x

38

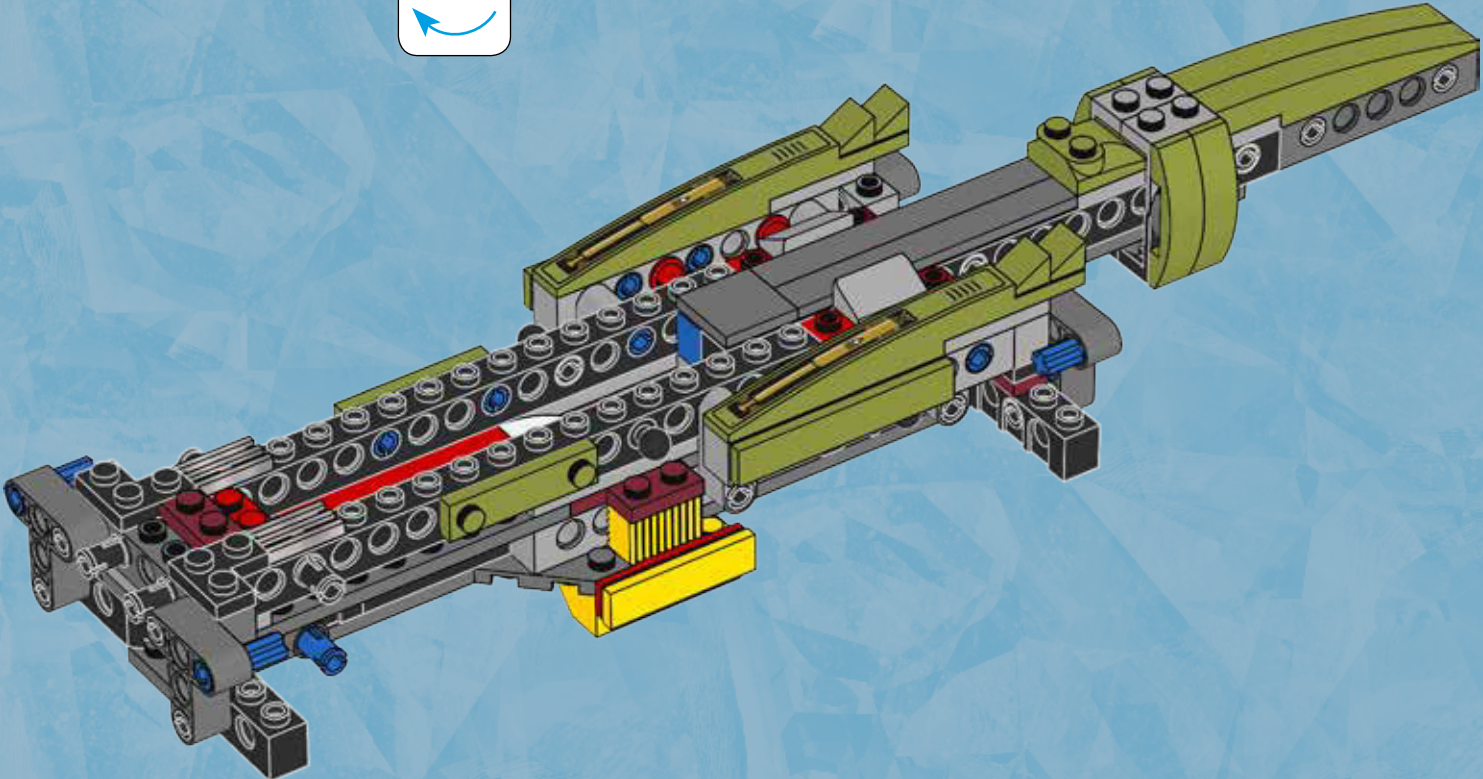

39

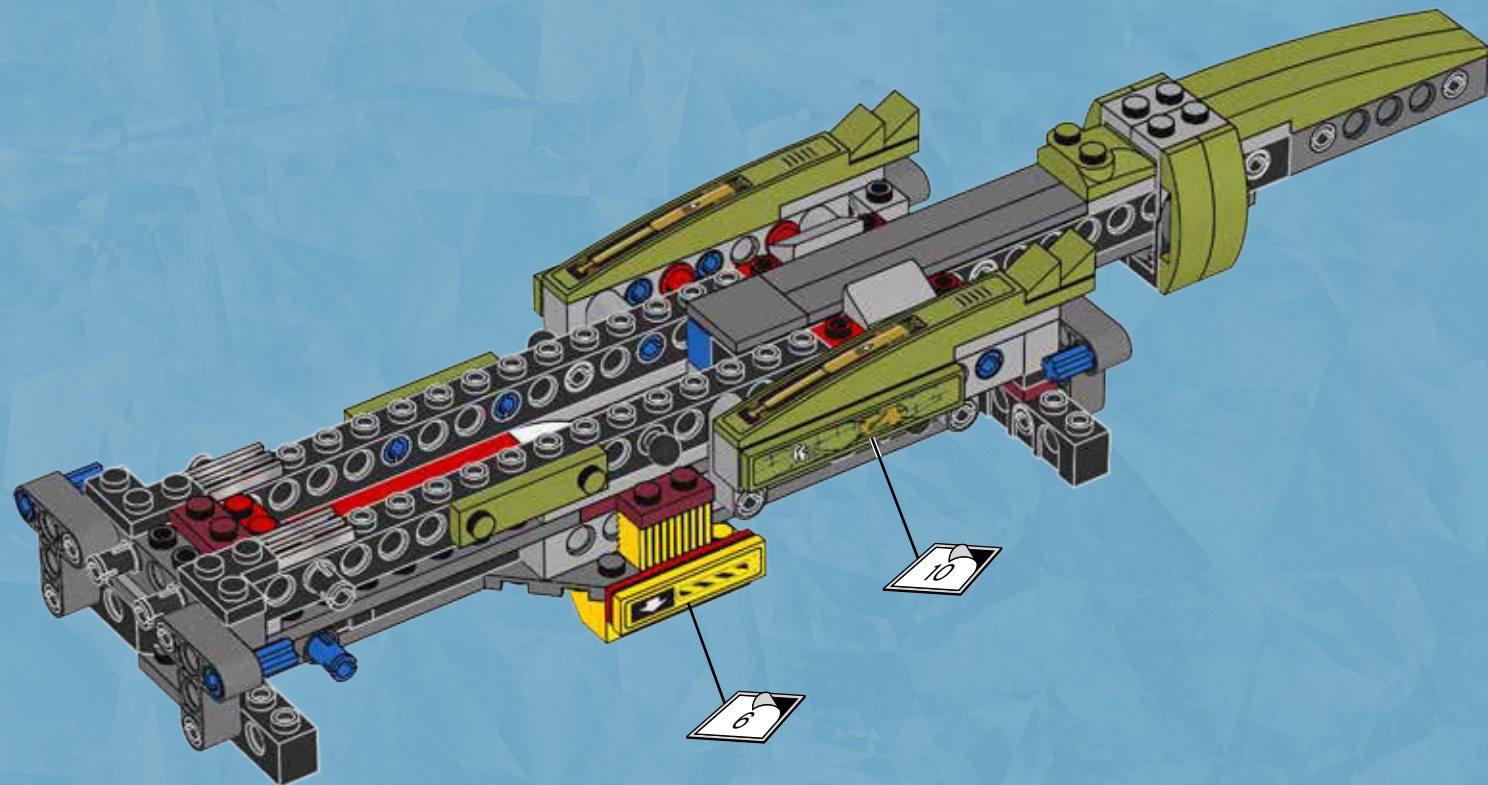

40

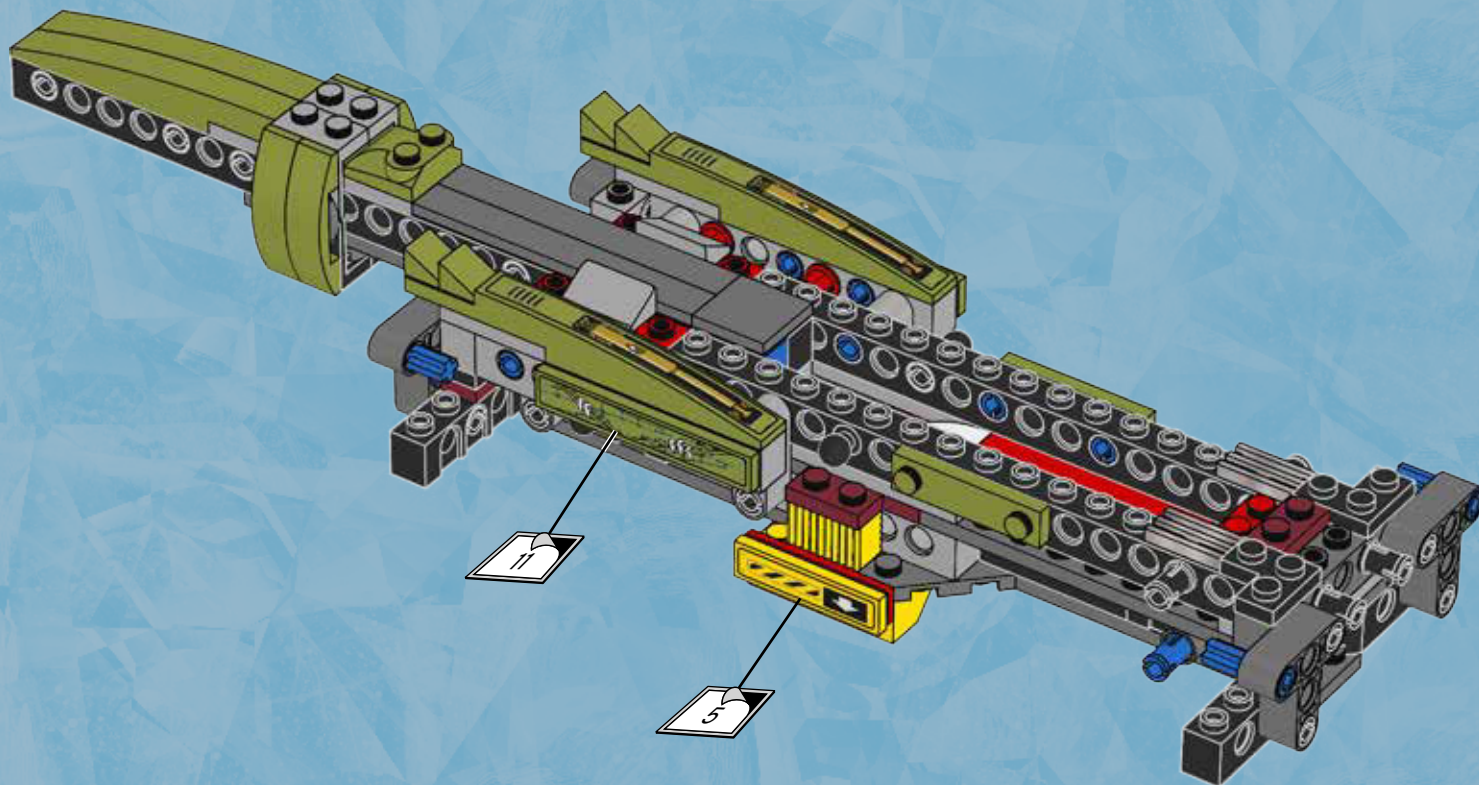

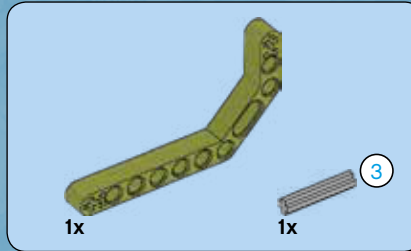
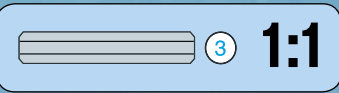
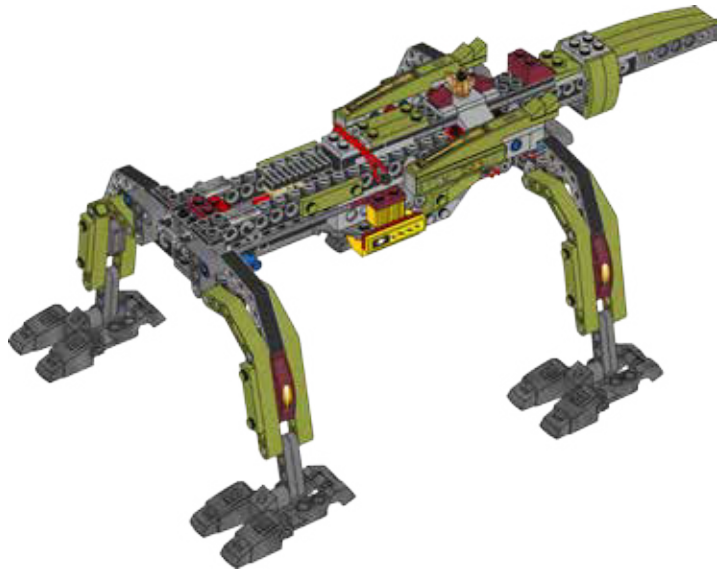
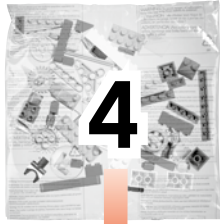

1

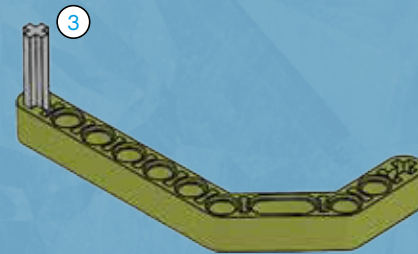



2x



2x

2

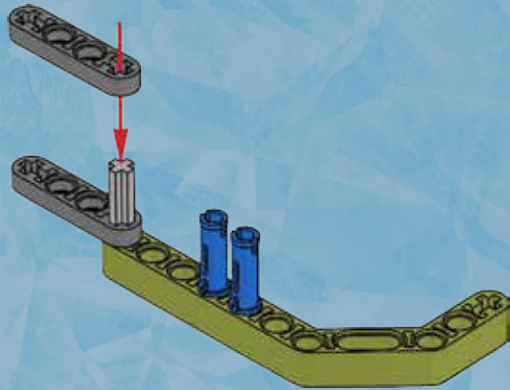

1x



1x

3

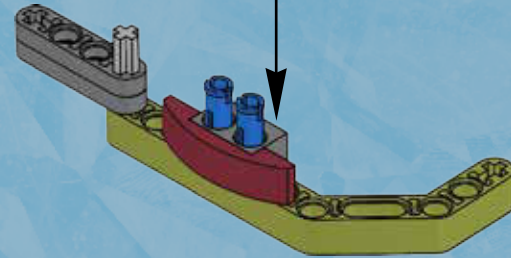
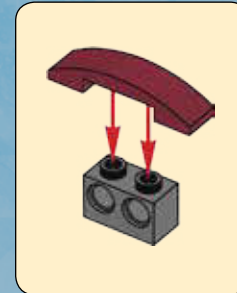

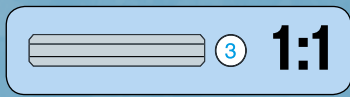
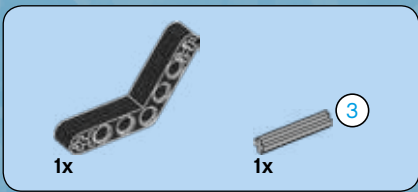

4

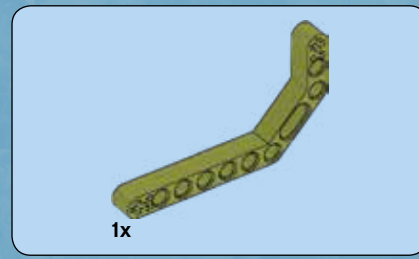
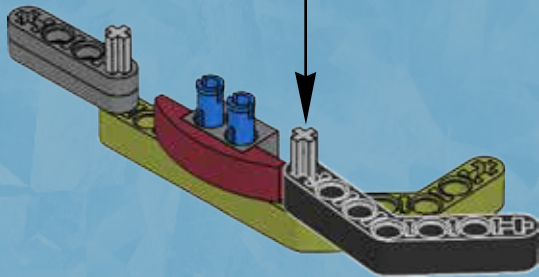
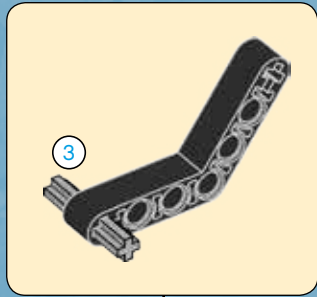

5

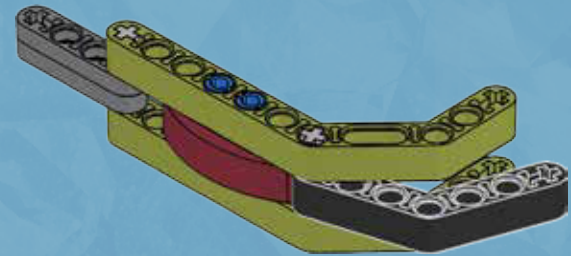

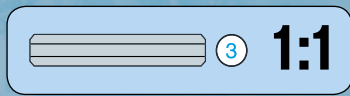
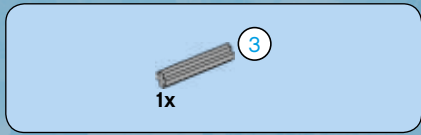

6

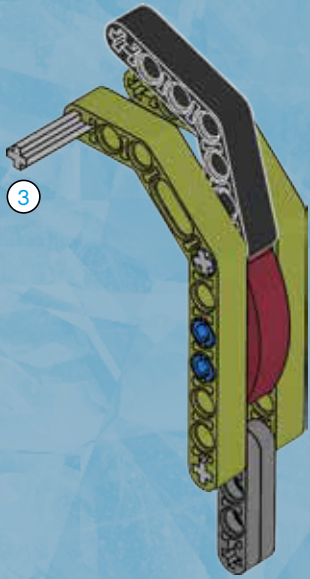

7

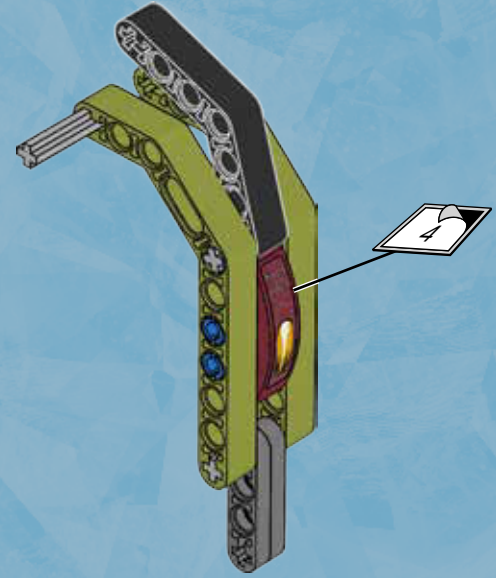

4x

41

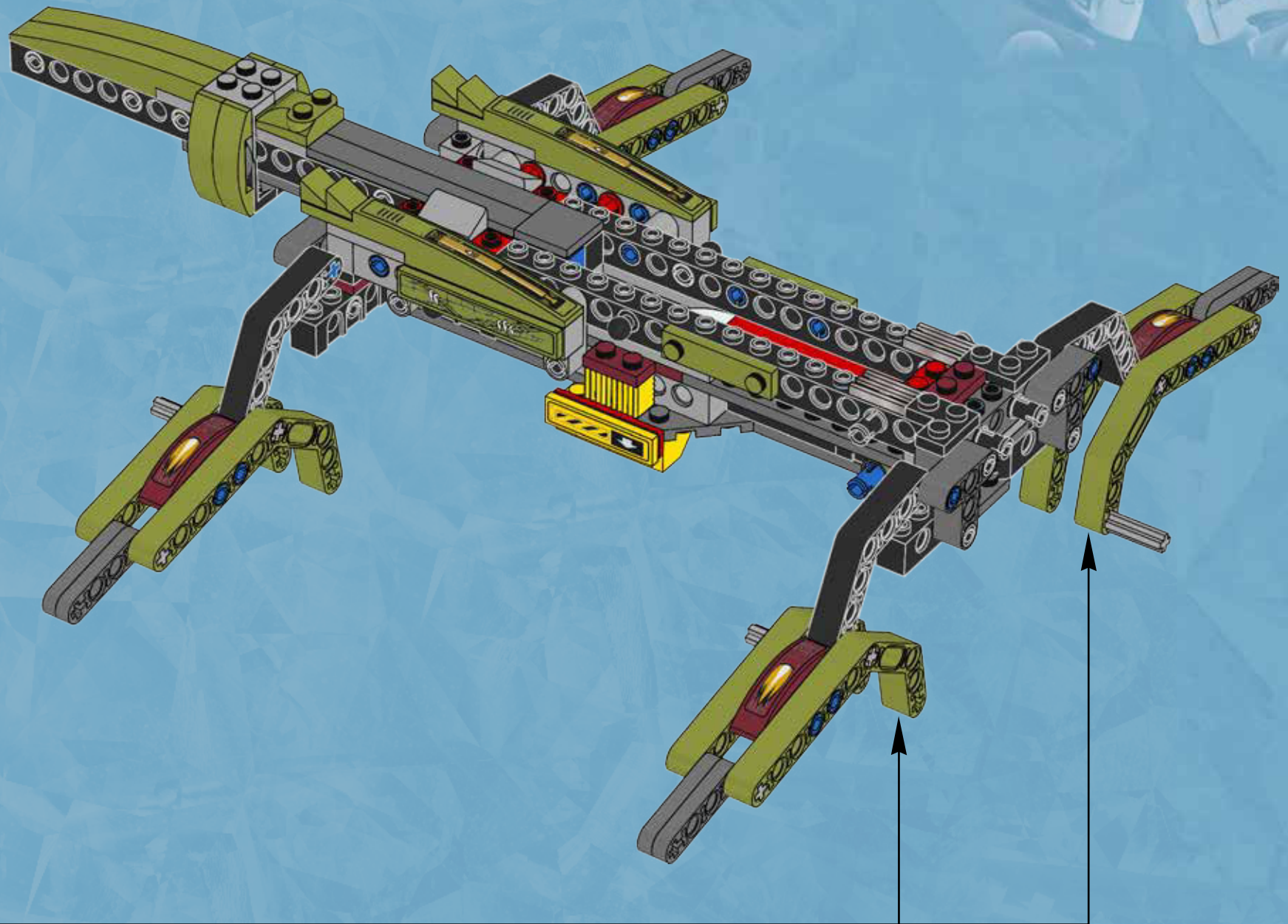

42

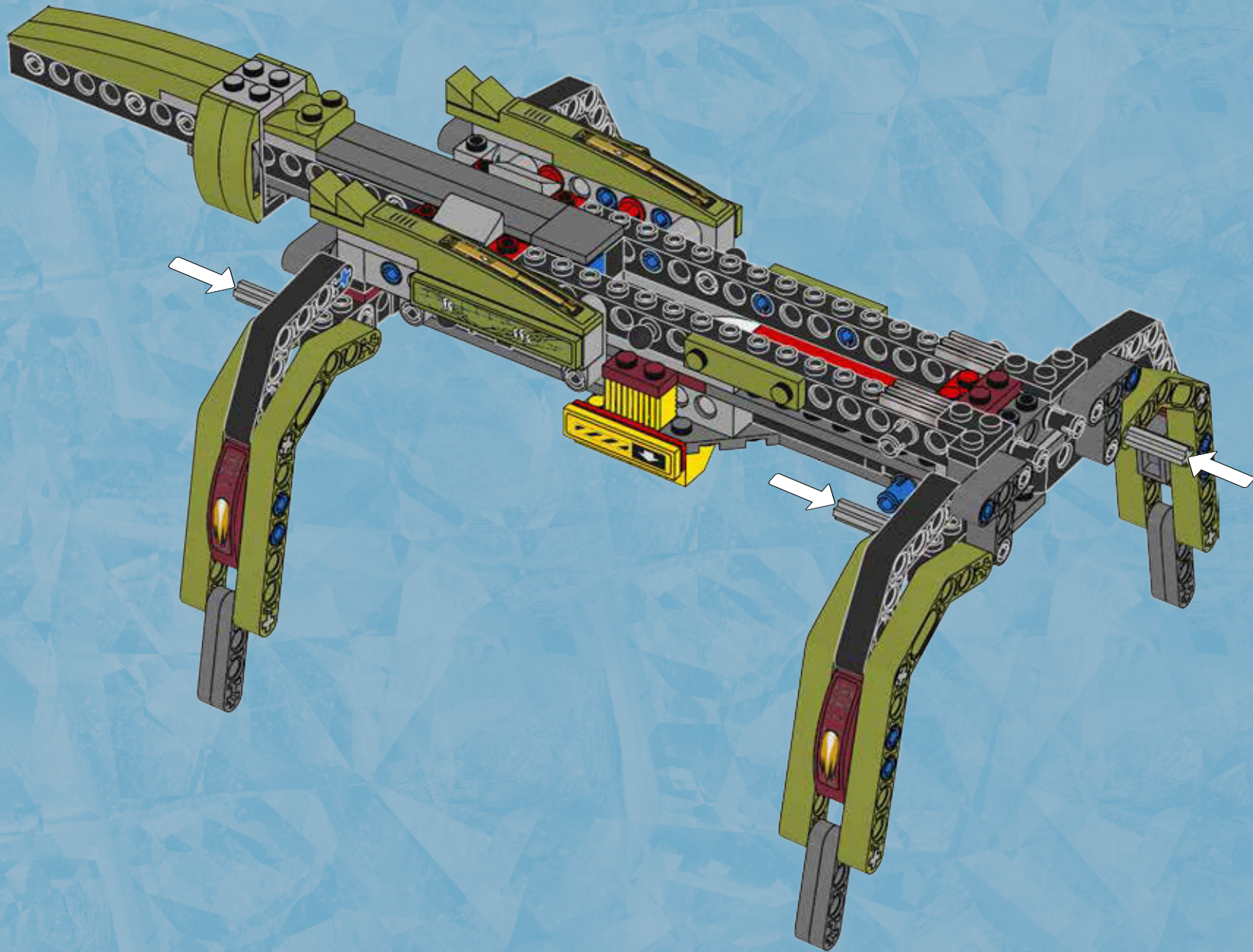



4x

43

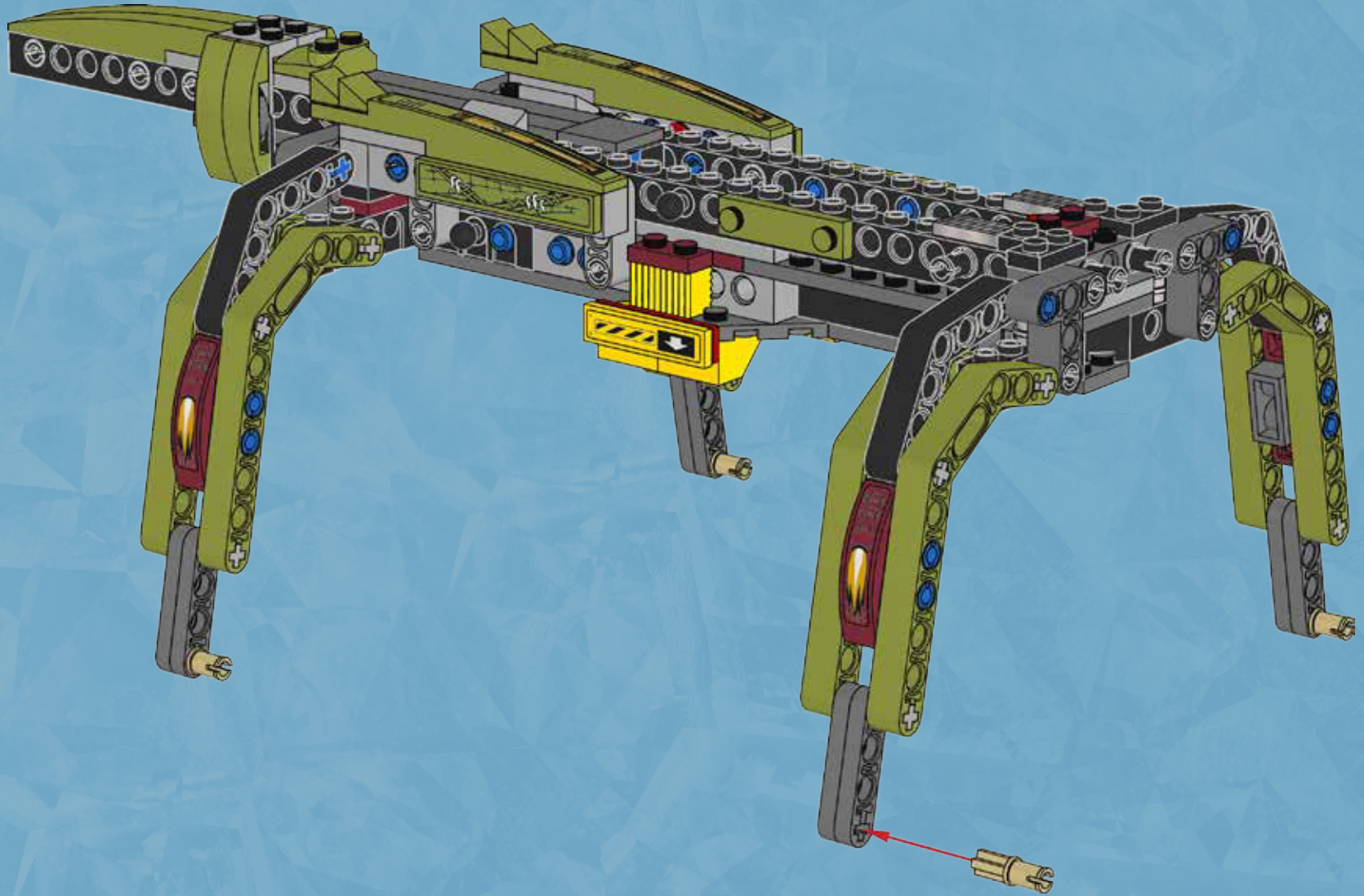



44

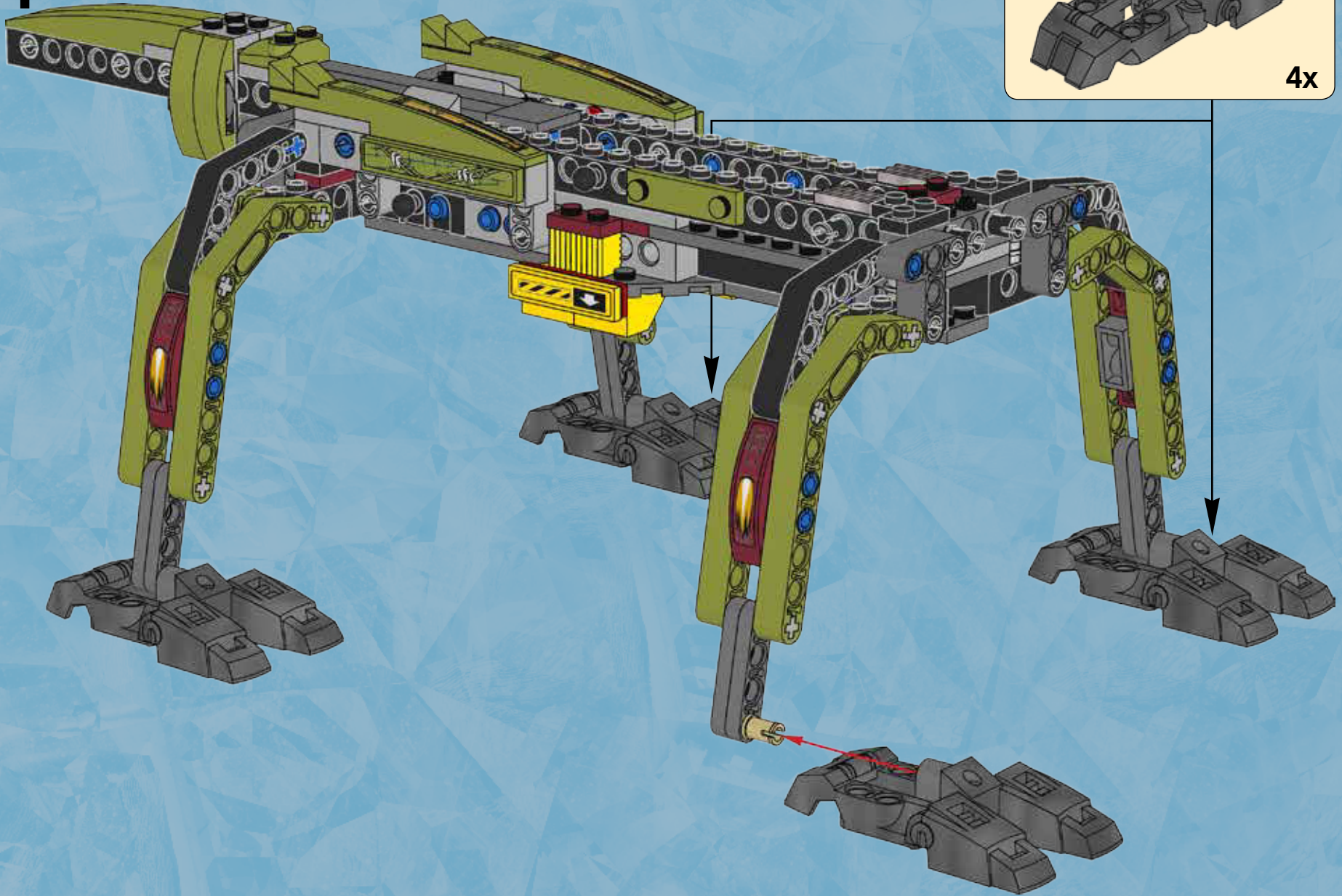
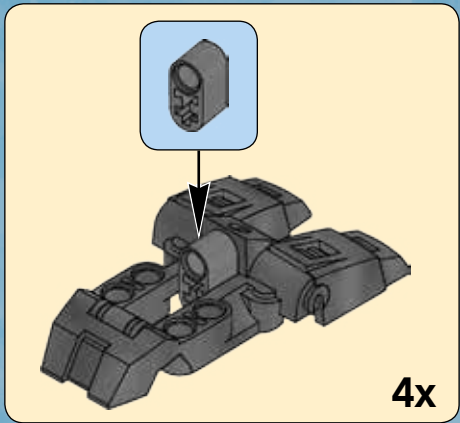

4x

45

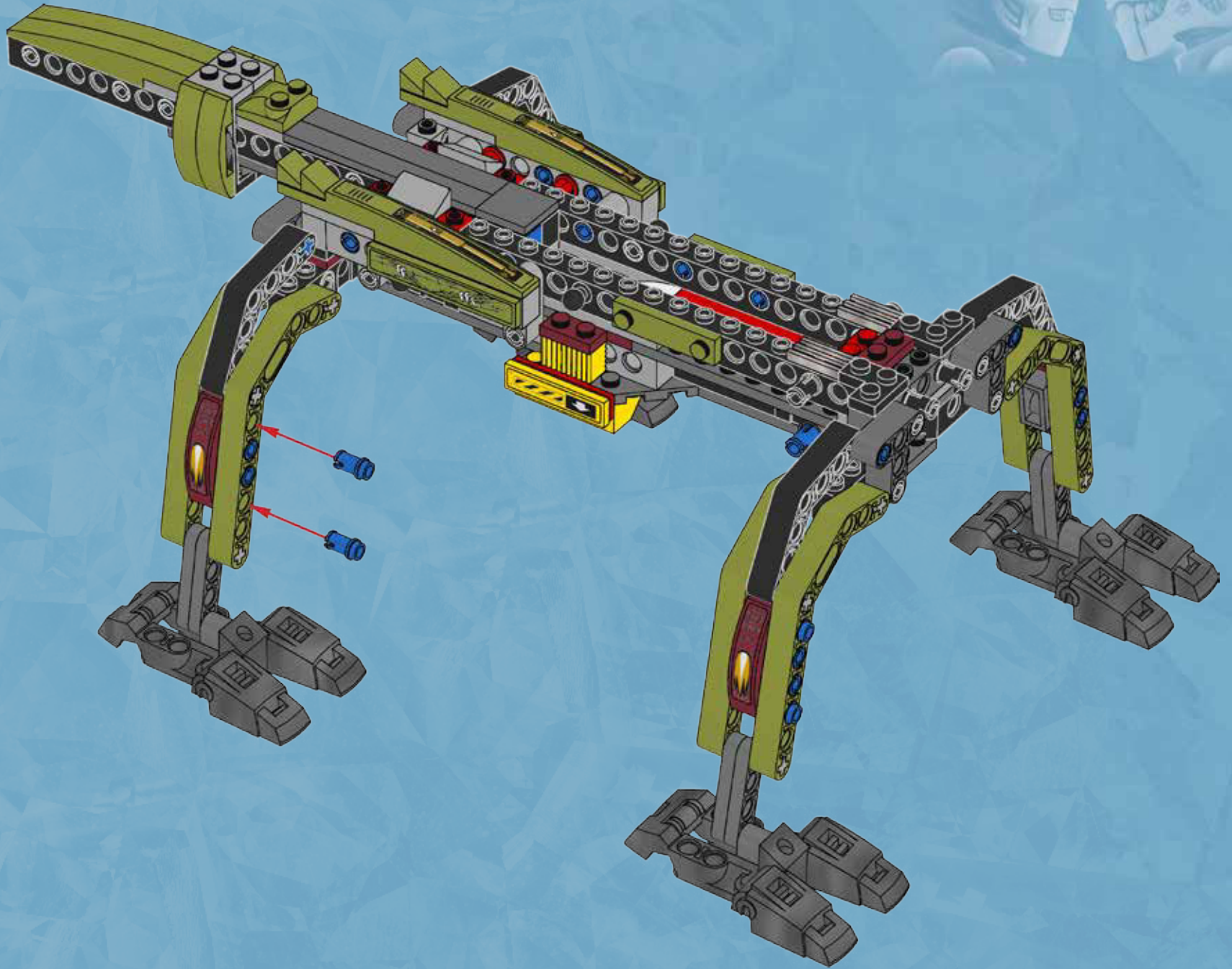



46

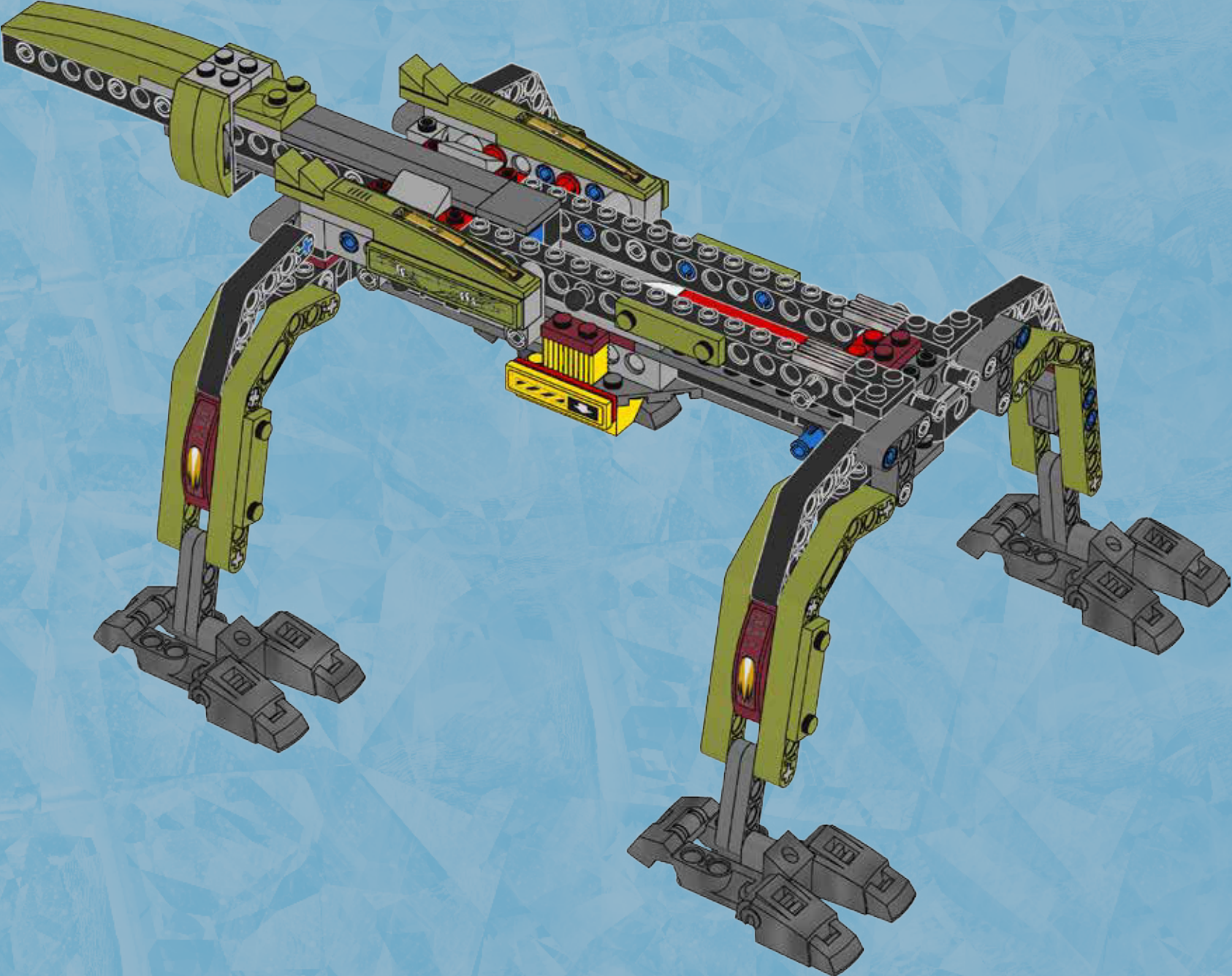

4x

47

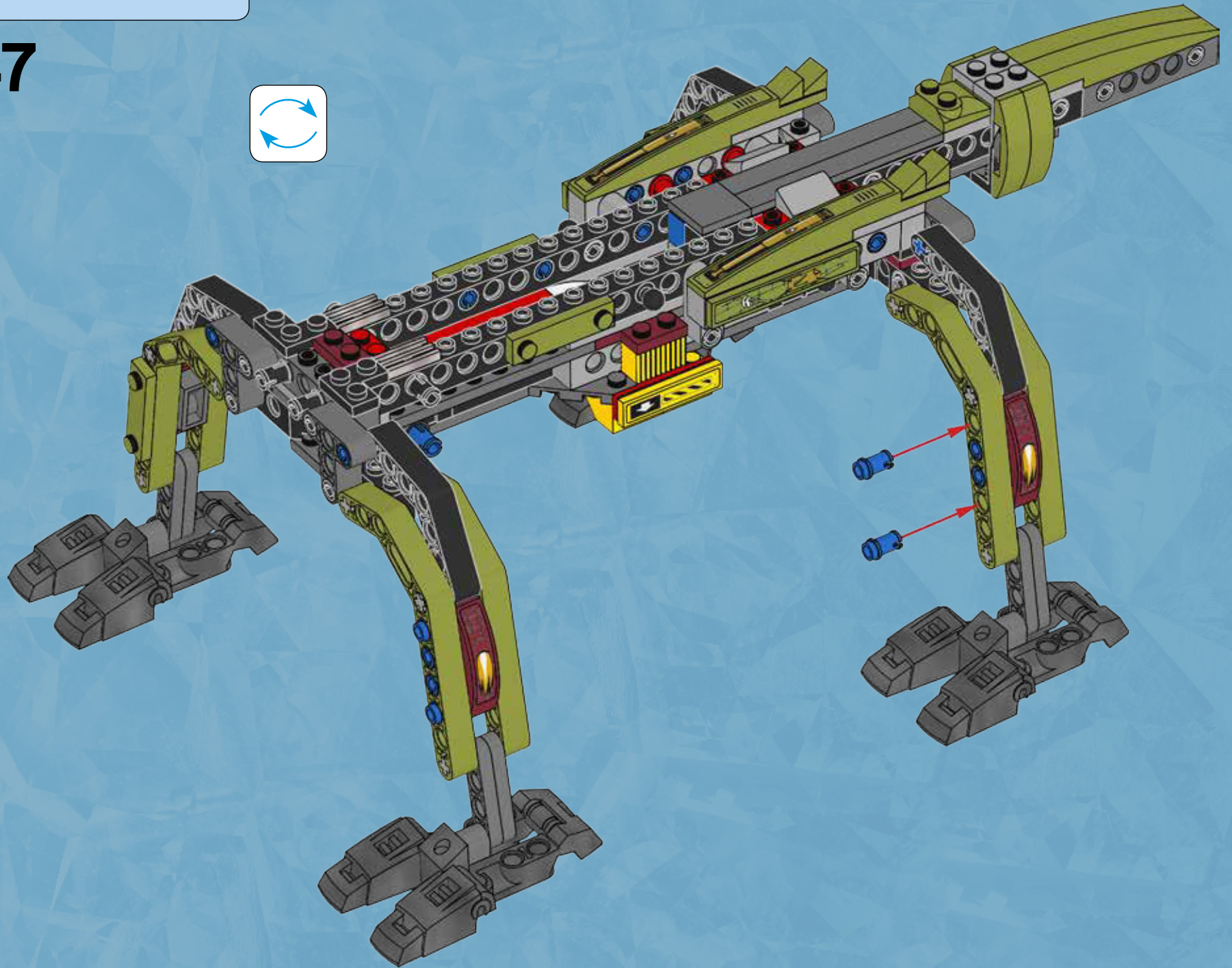



48

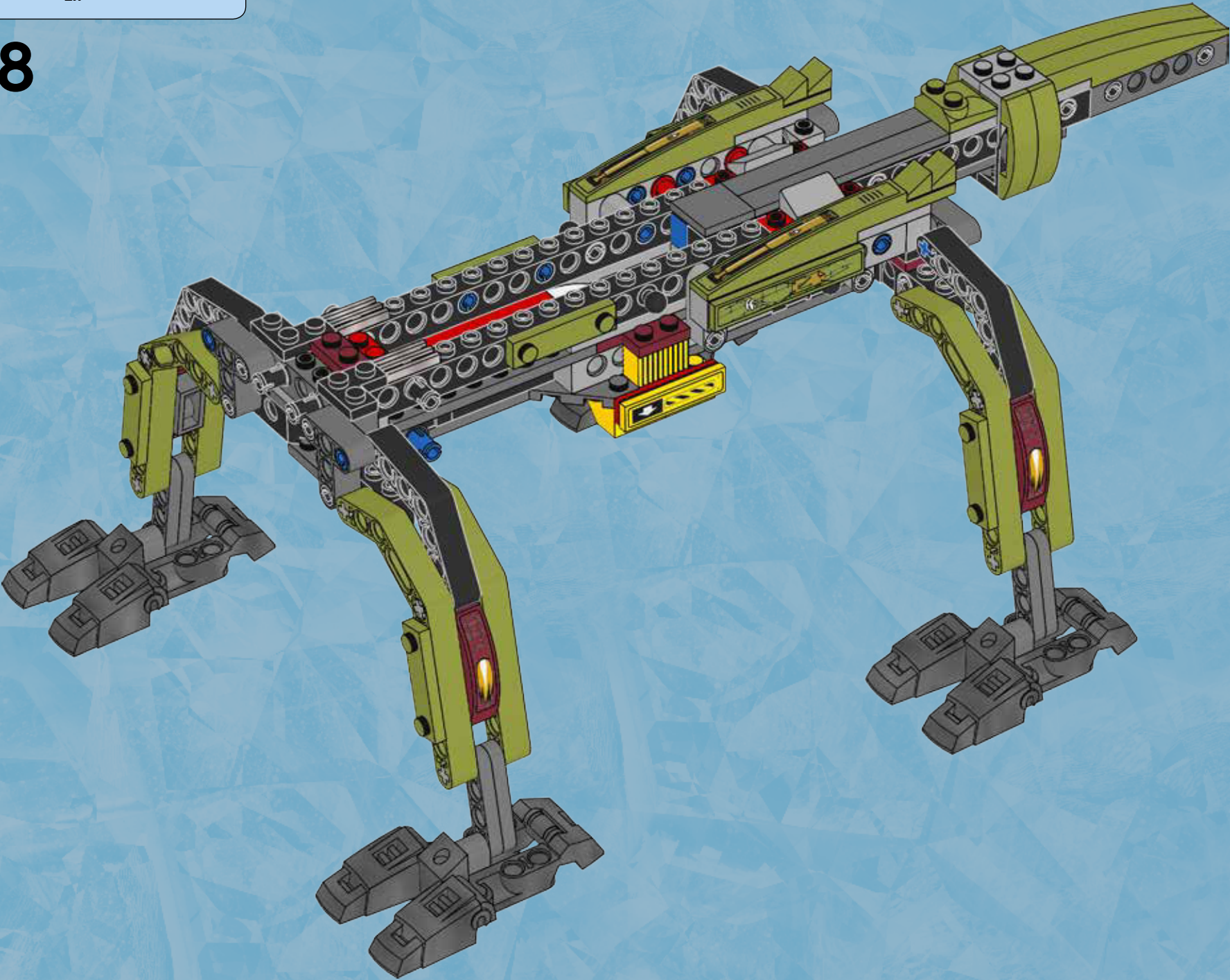



1



2

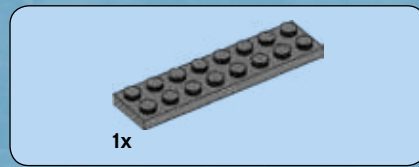

3



4



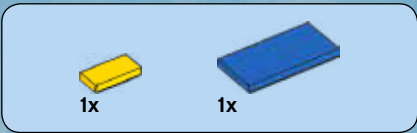

5

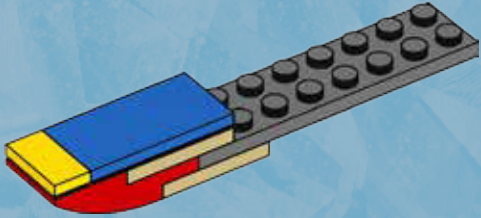

6

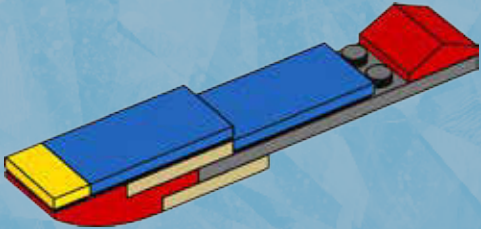

7

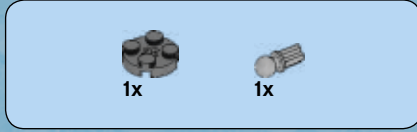
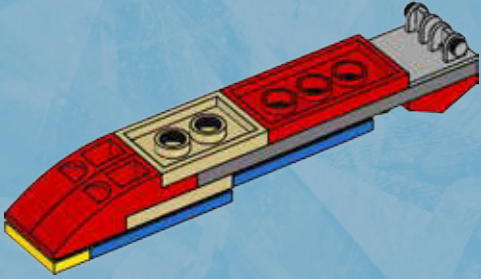

8

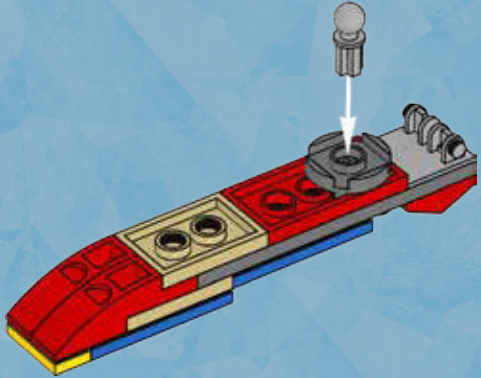

49

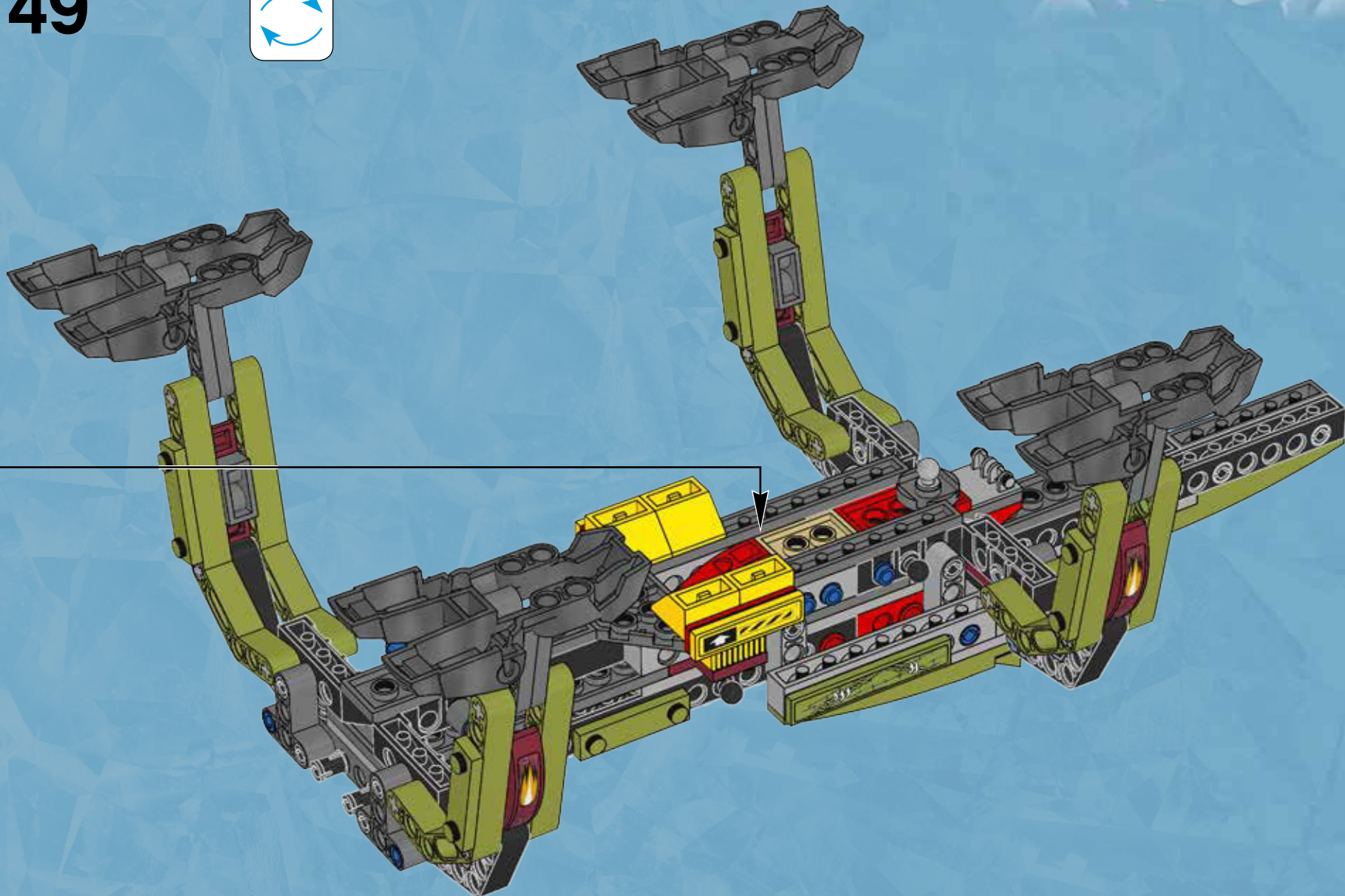

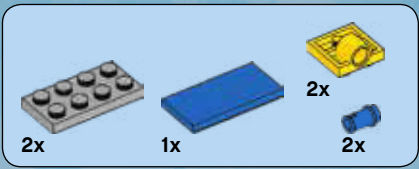

50

1

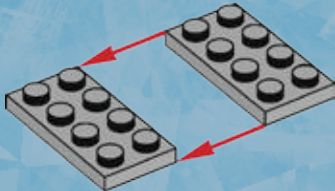

2

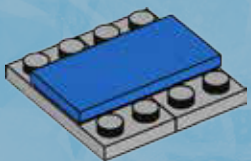

3

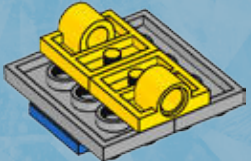

4

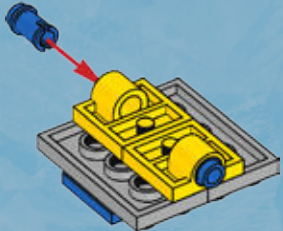

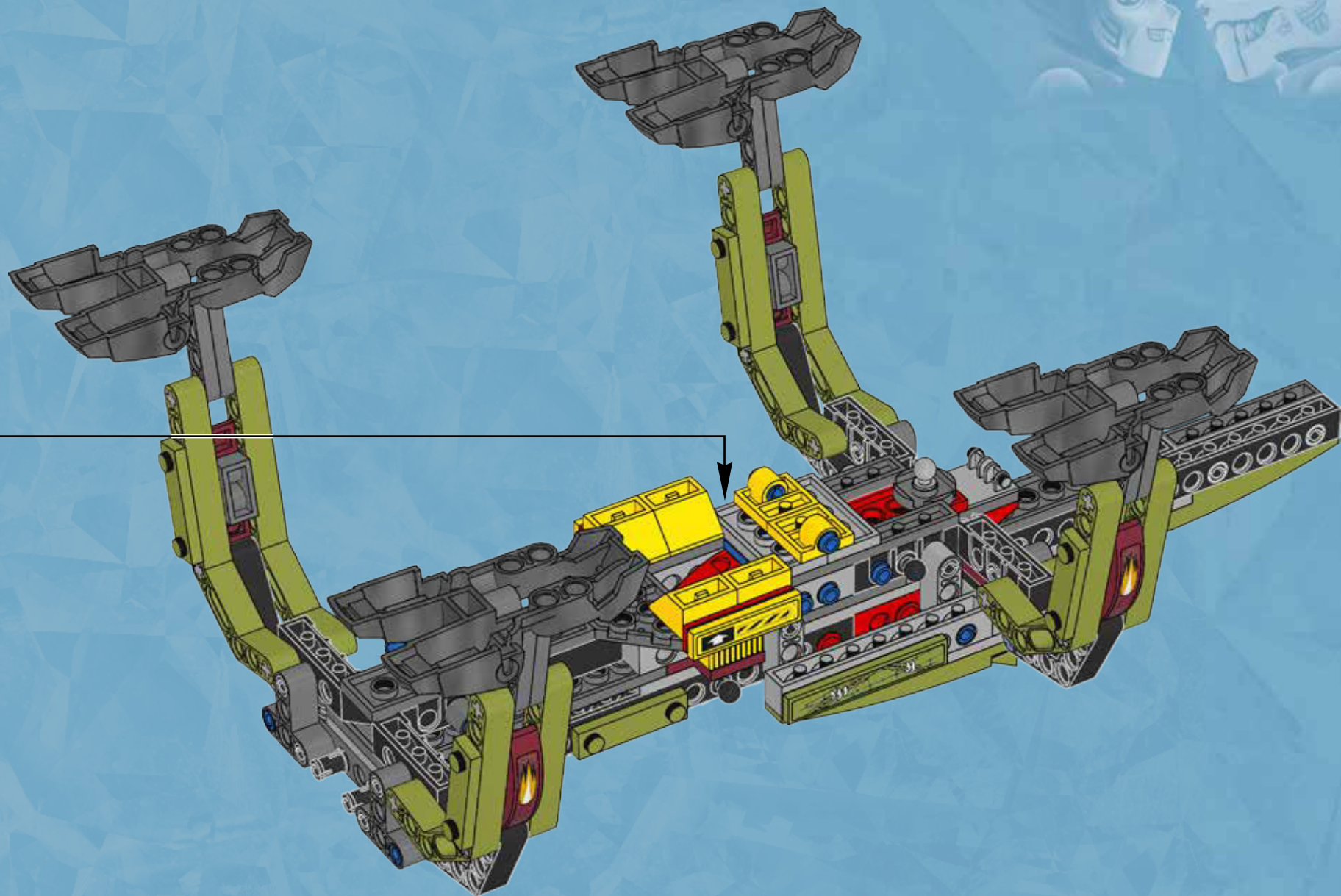



1x

51

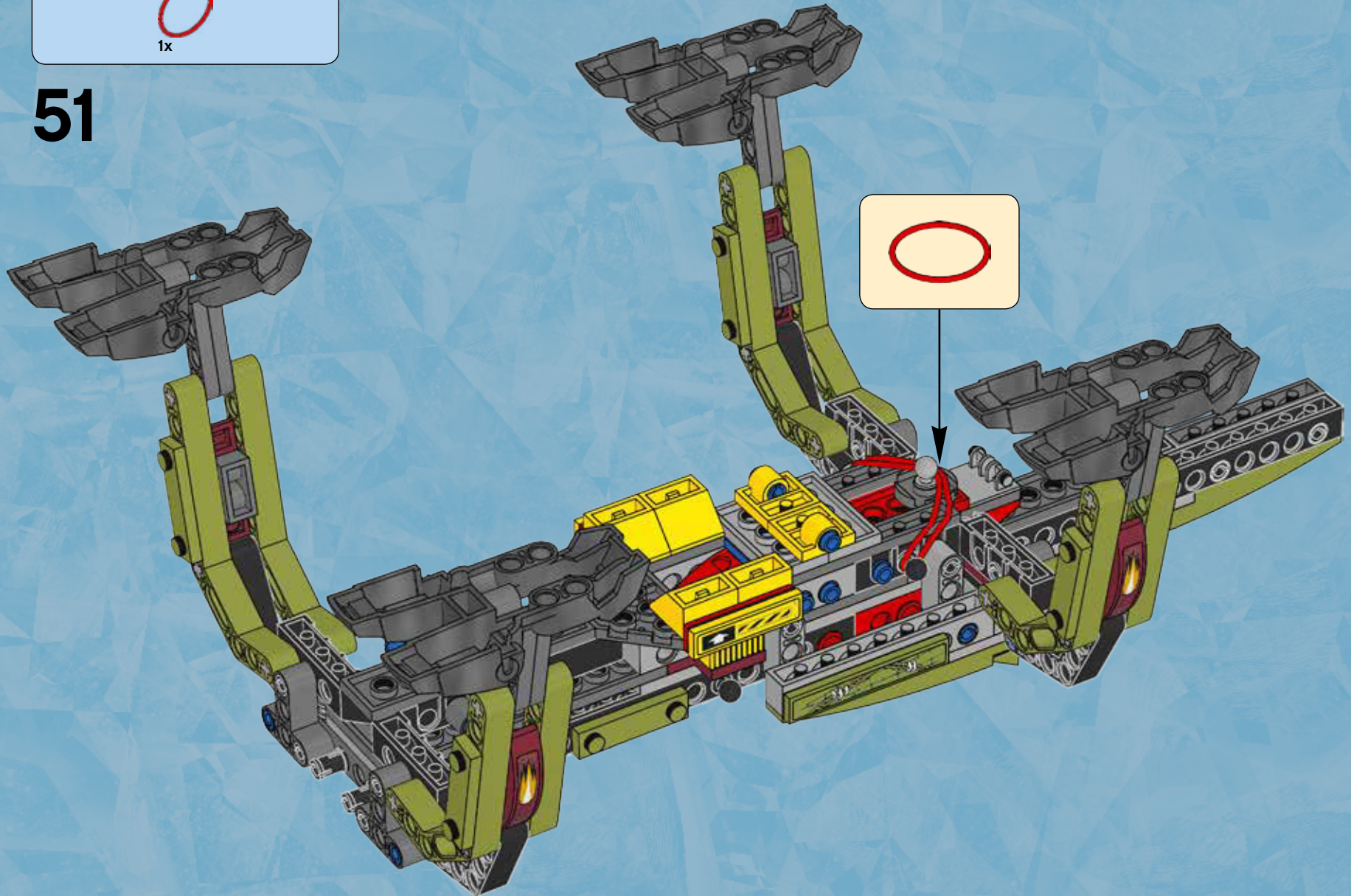

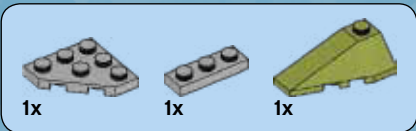

52

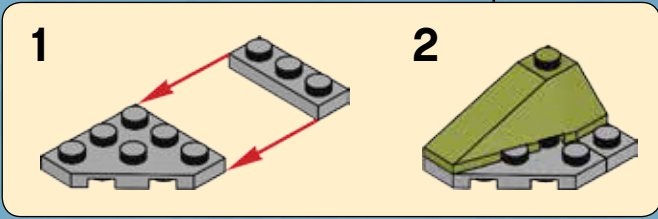
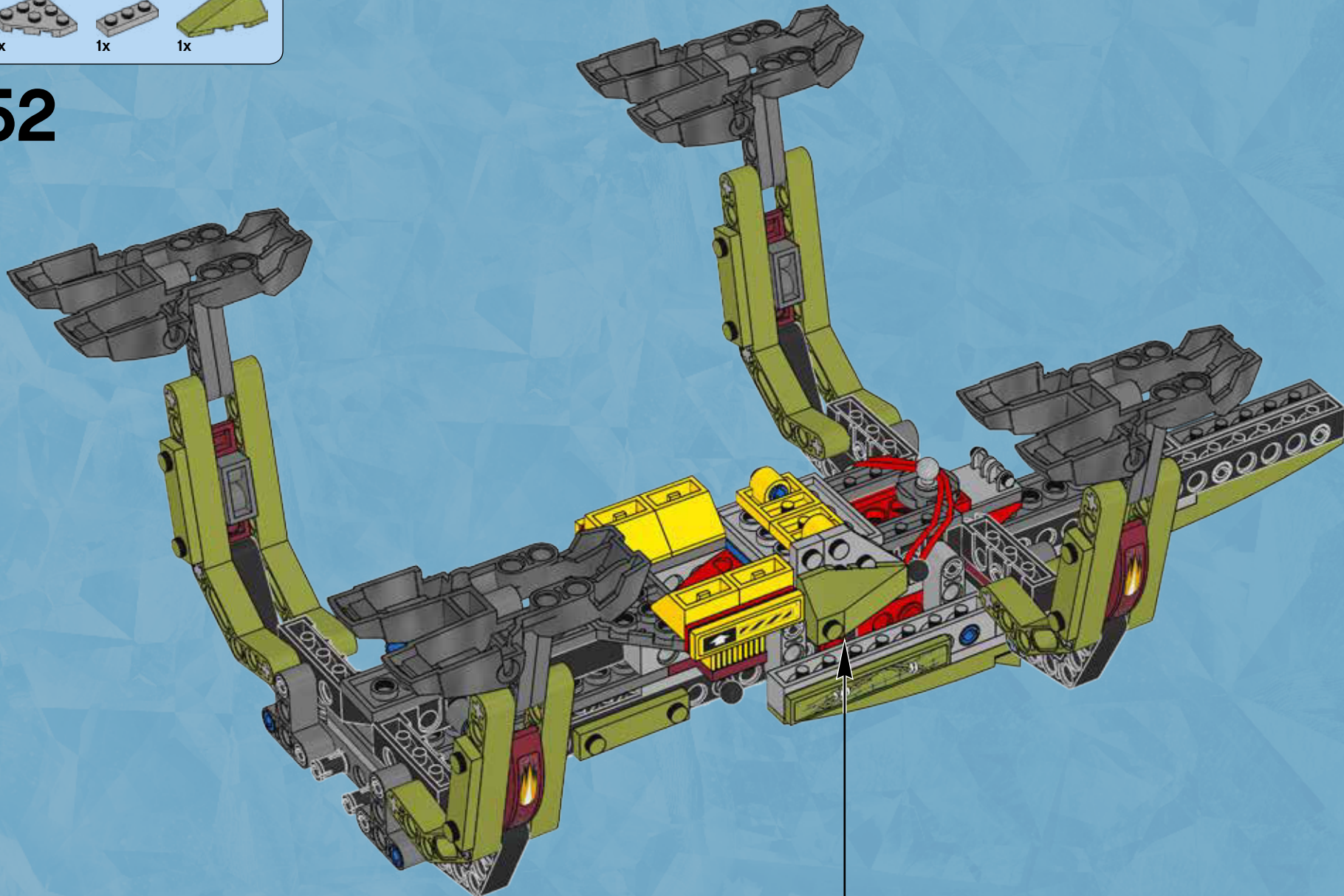



1x



1x



1x

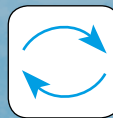

53

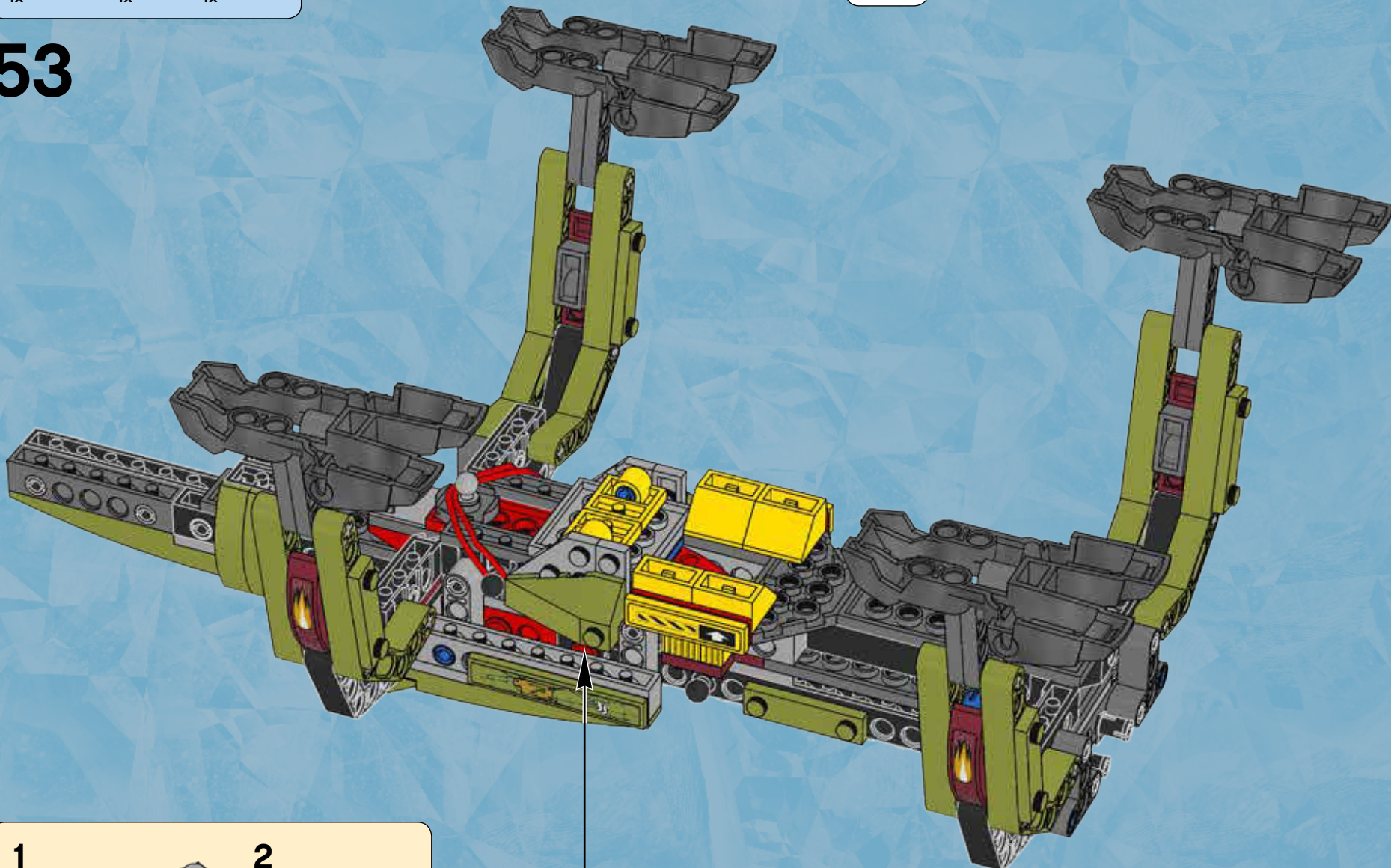

1

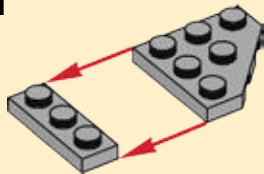

2

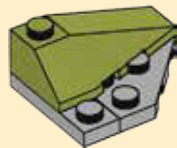

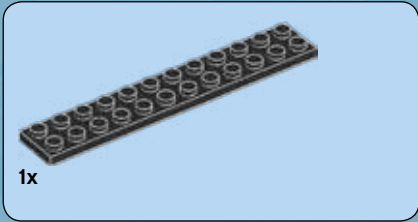
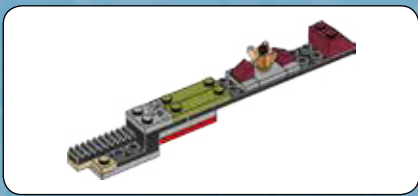

1x

1

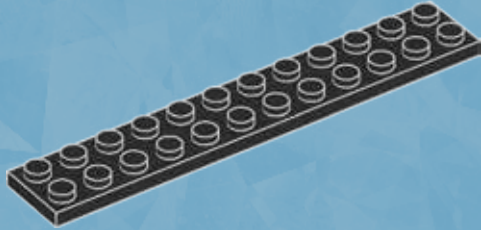

1x

2x

2

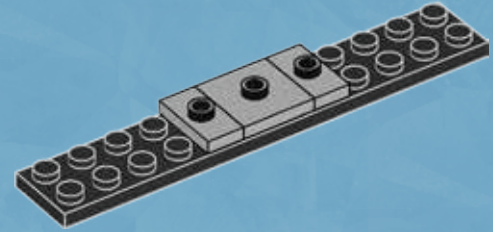

2x

3

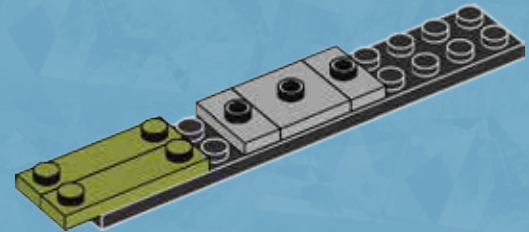

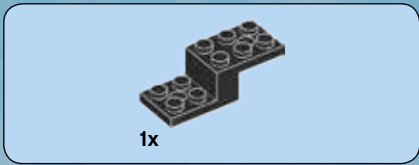

4

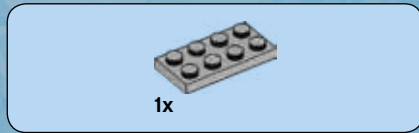
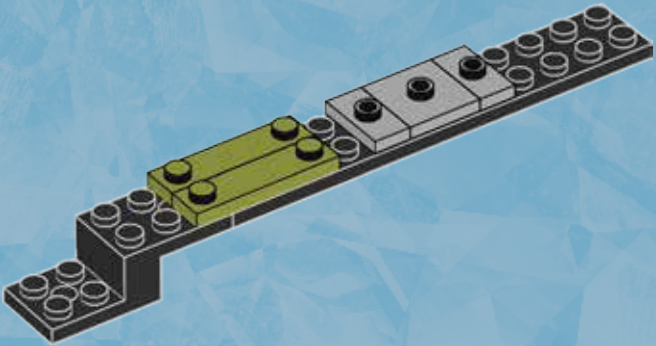

5

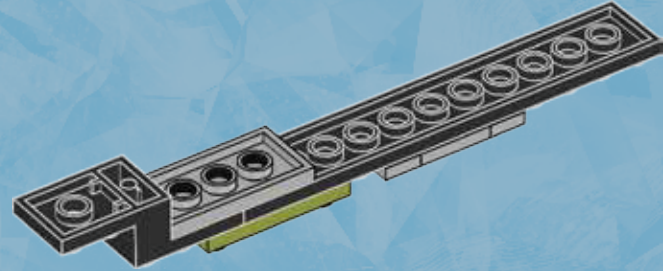

6

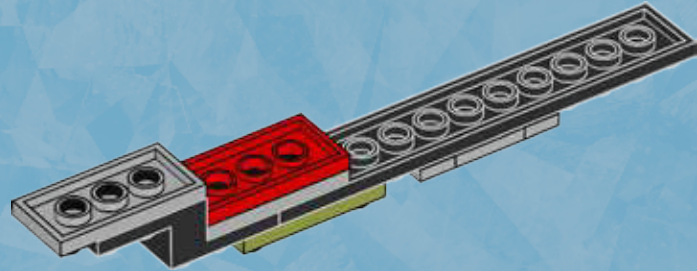



7

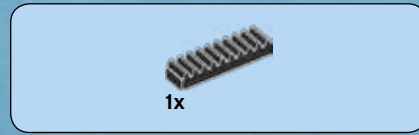
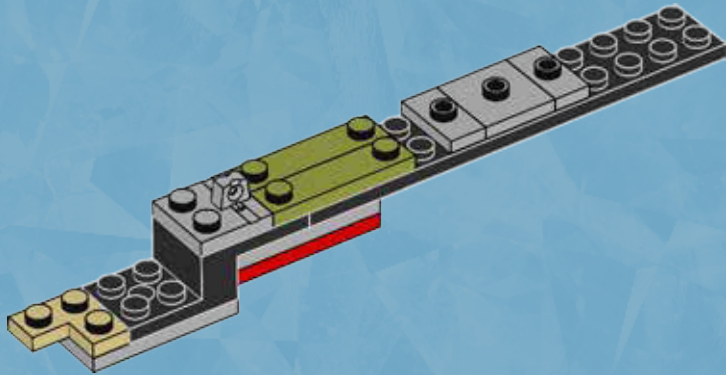

8

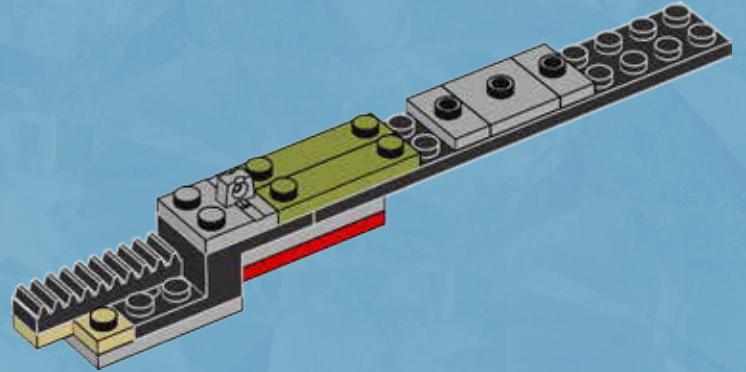

9

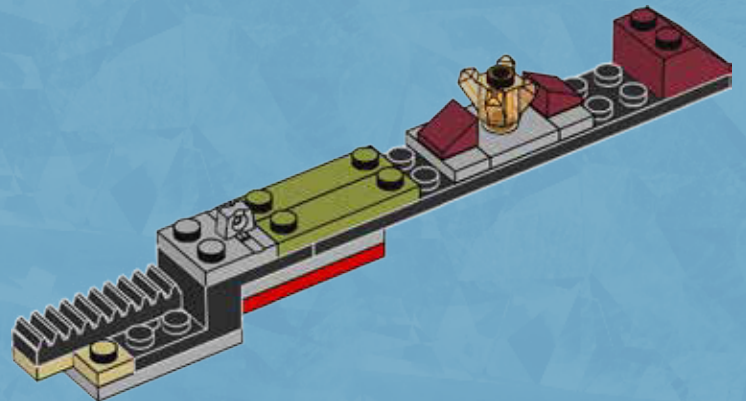

54

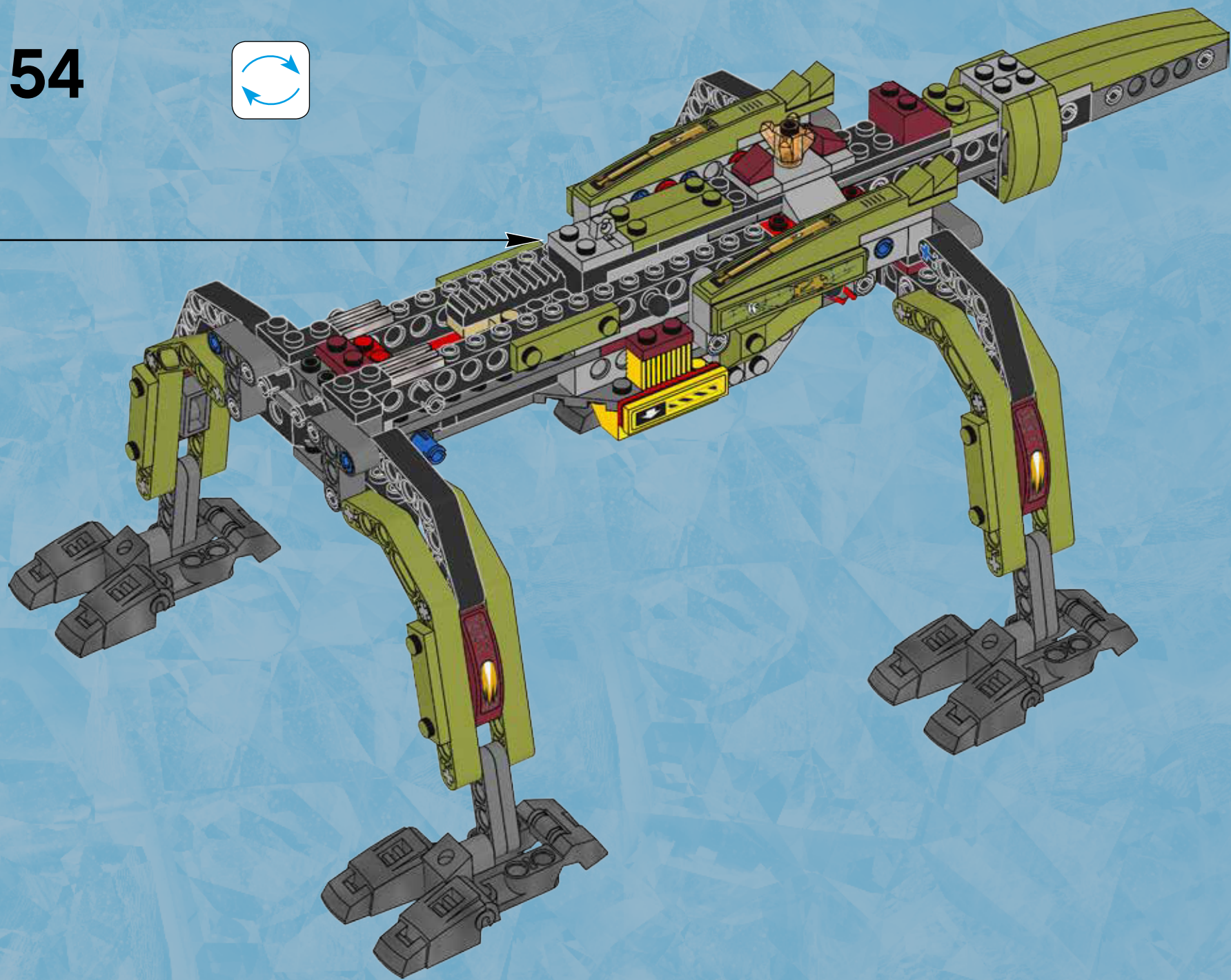



1x

55

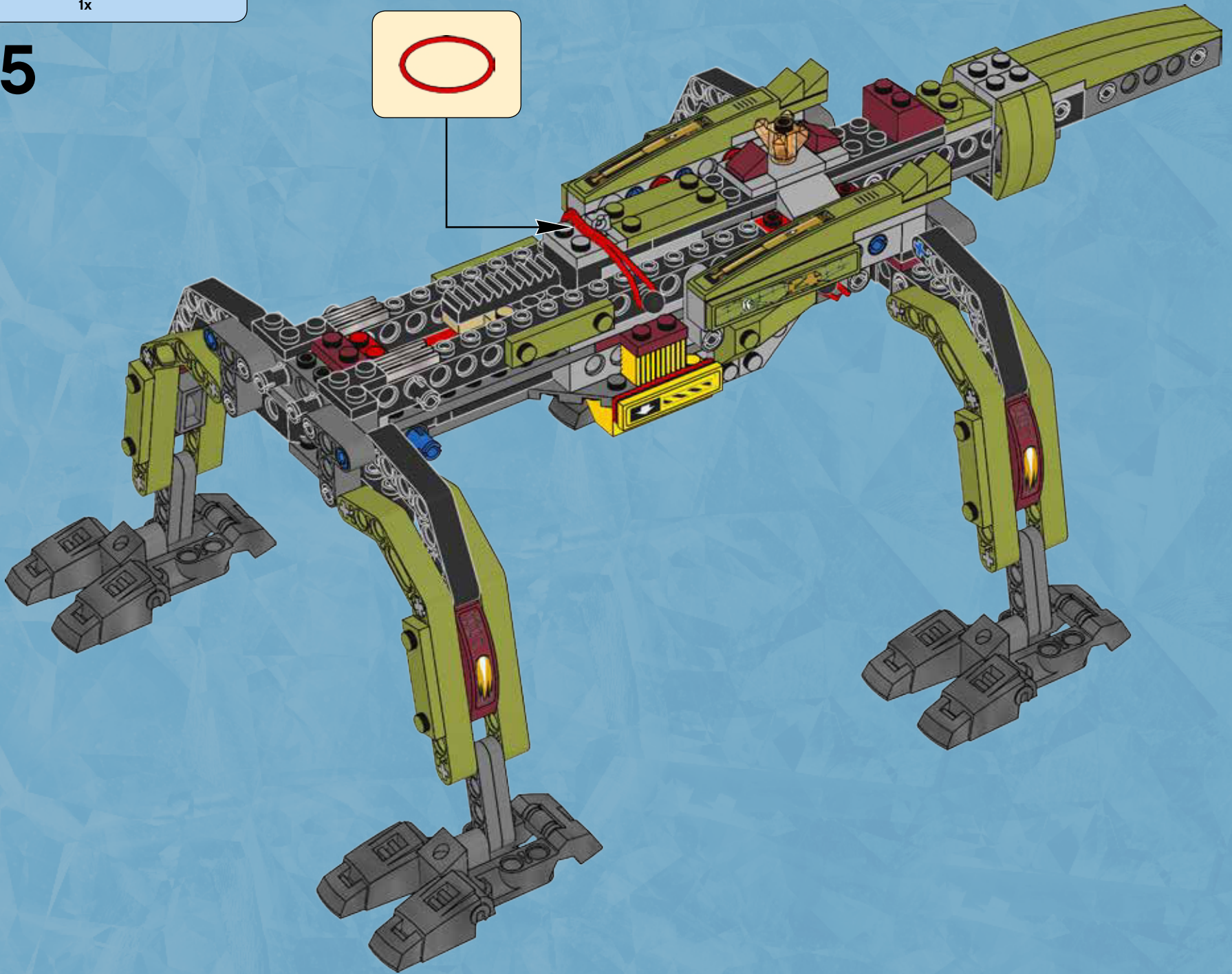
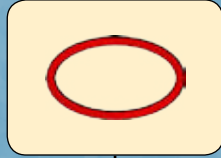

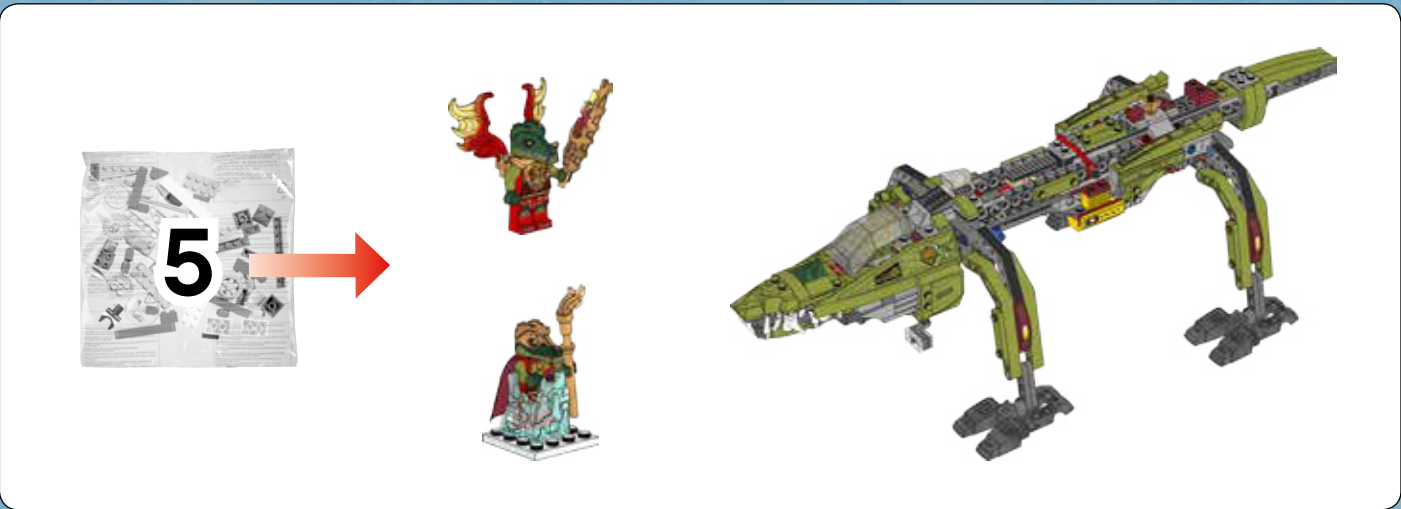

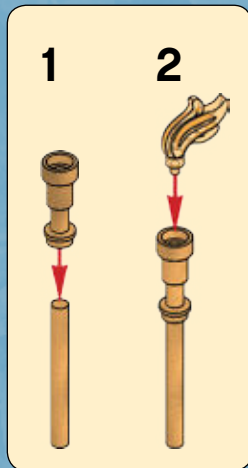
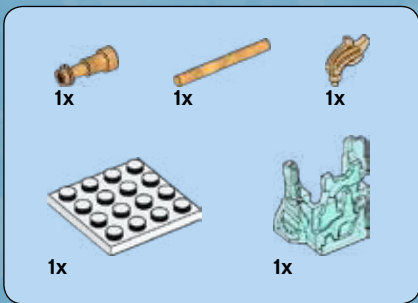

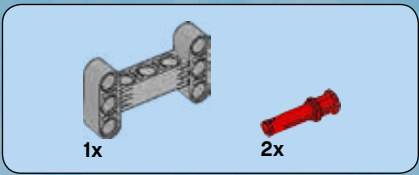

56

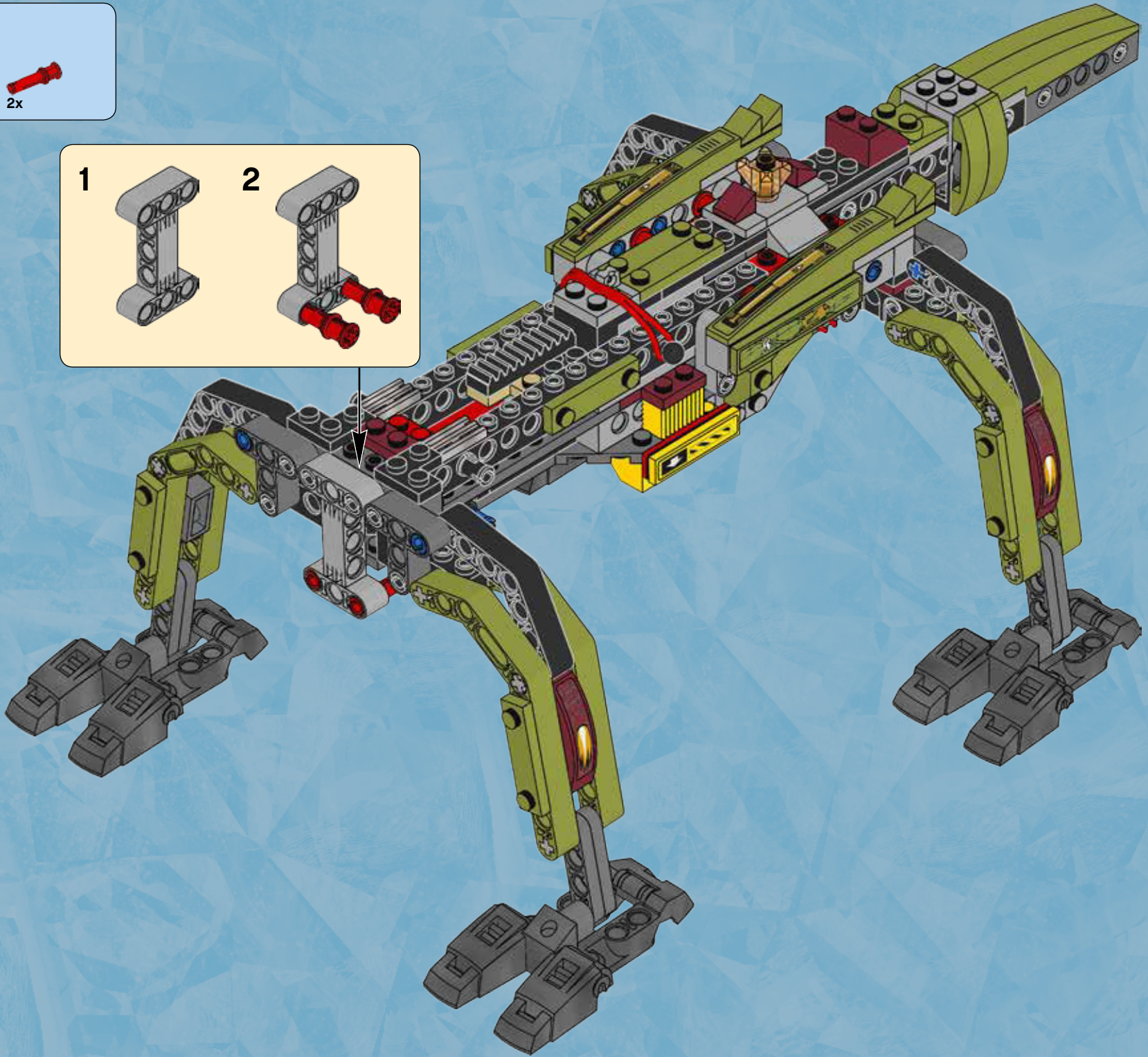
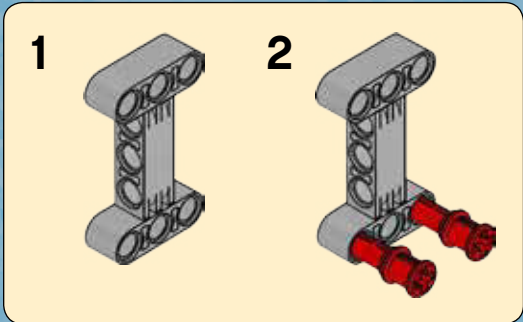

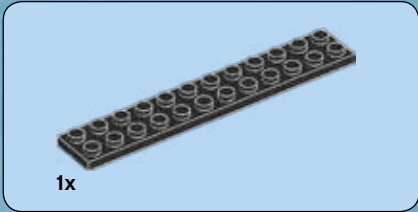

1

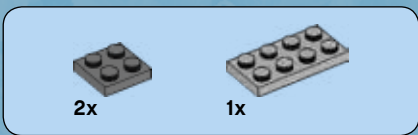
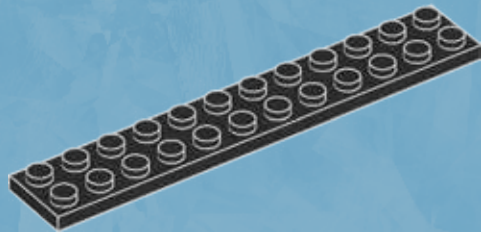

2

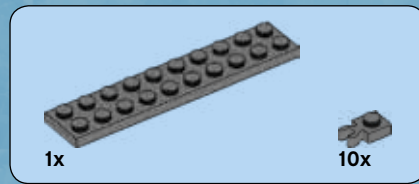
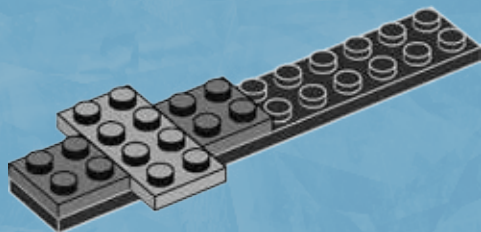

3

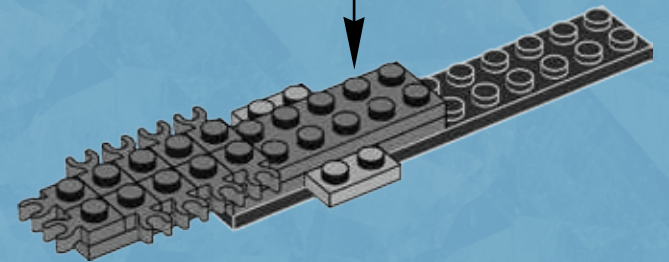
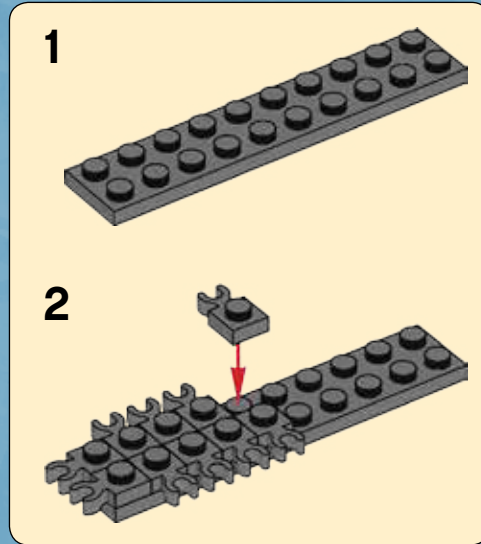



2x



2x

4

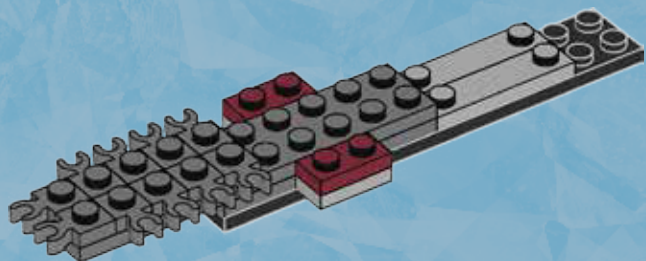

2x

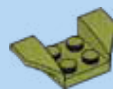

1x

5

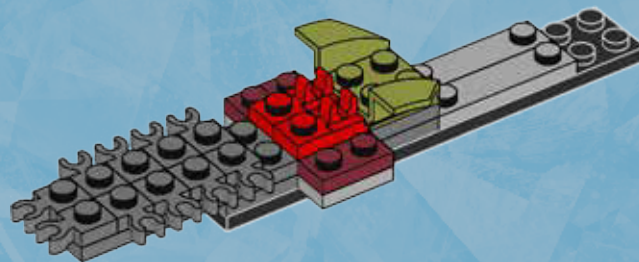

2x

6

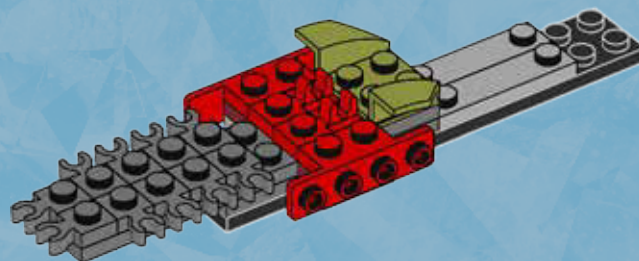



7

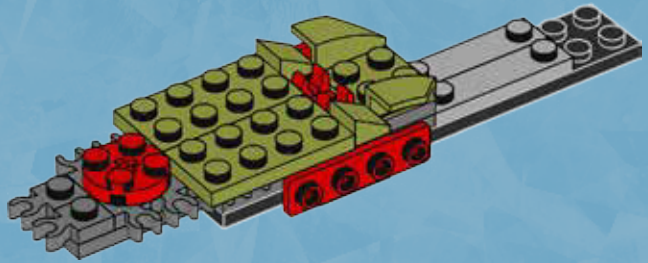

8

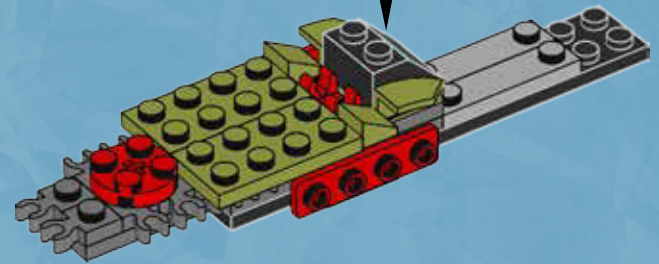

9

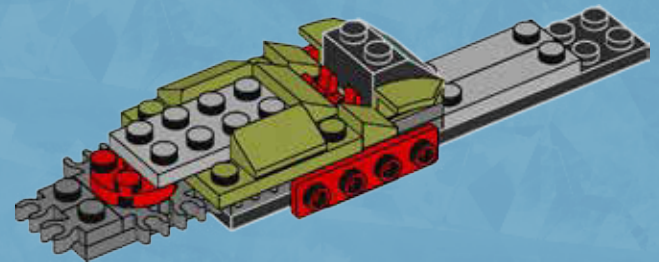



1x



2x

10

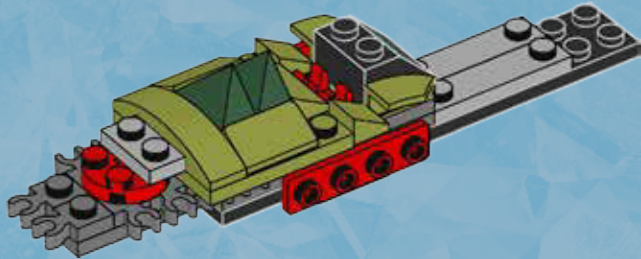

1x

11

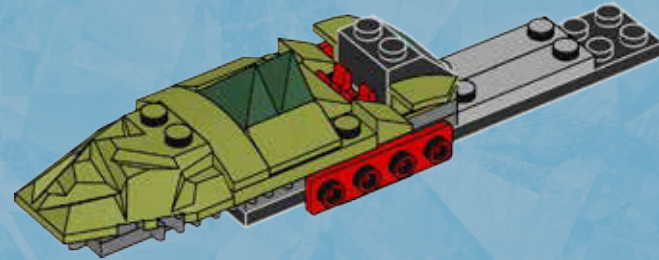

2x



8x

12

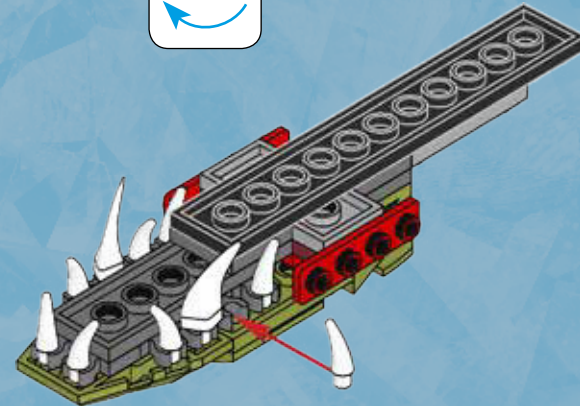
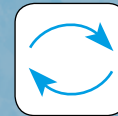

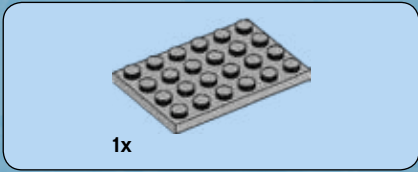

1x

1



2x

2

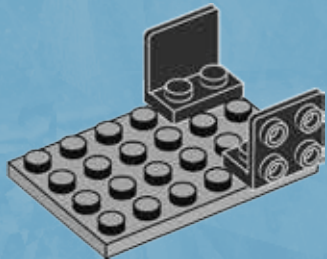

2x

3



2x

2x

4

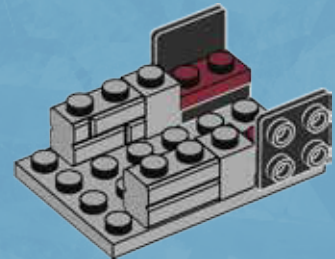



1x



1x

5

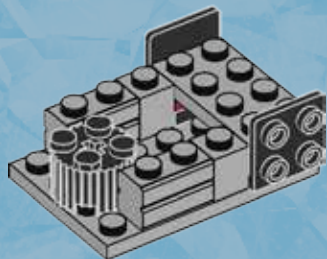

2x

6

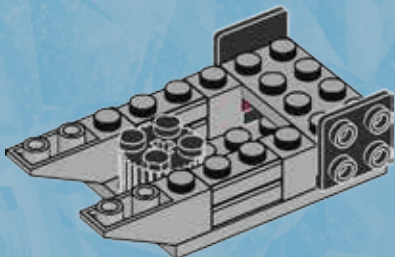

1x



1x

7

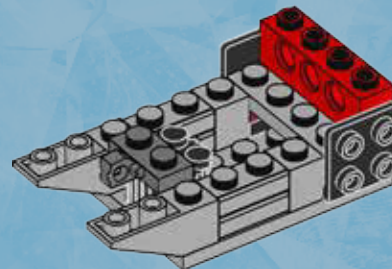

2x



1x

8

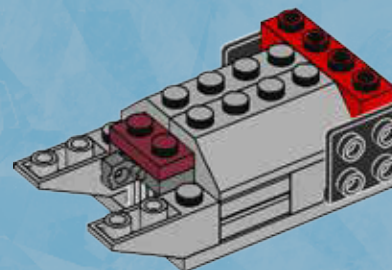



9

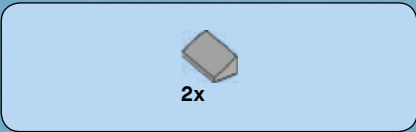
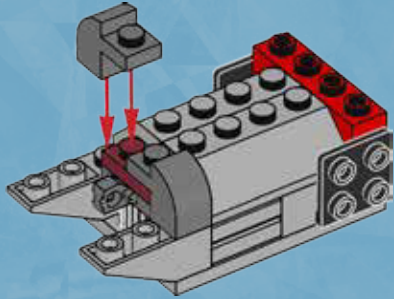

10

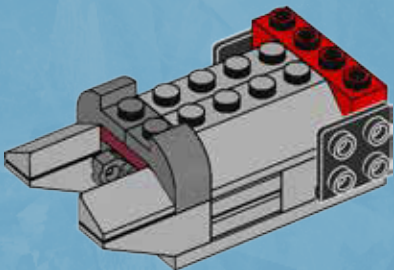

13

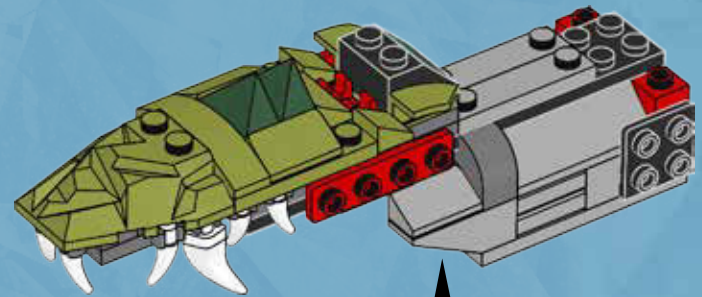
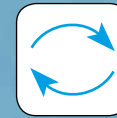



1x

14

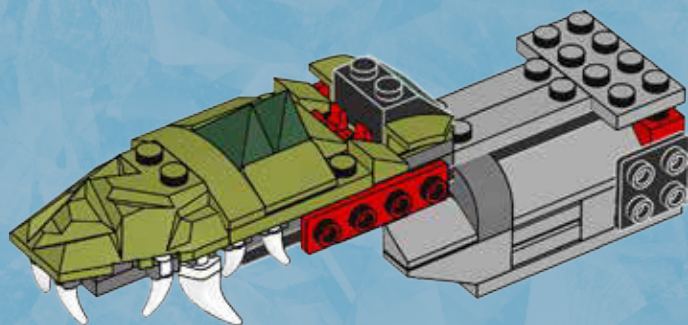

2x



1x

15

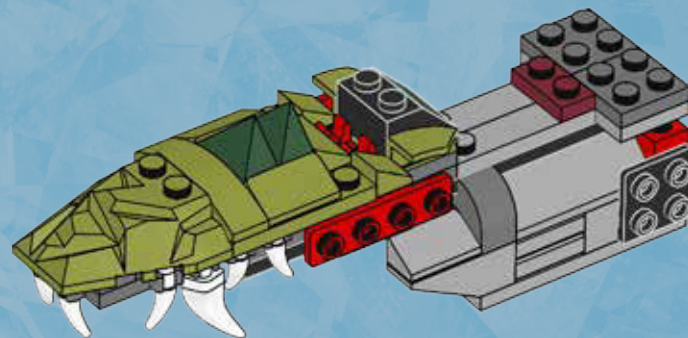

1x



2x

16

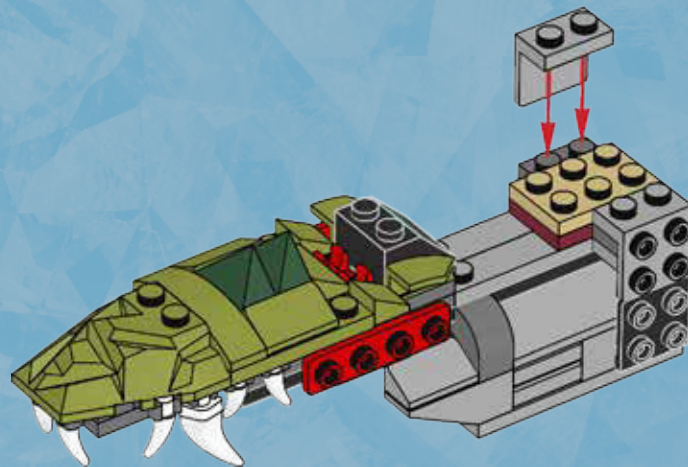

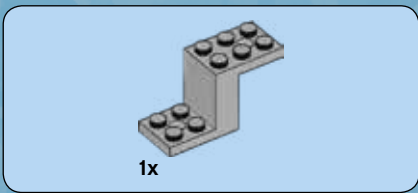

17

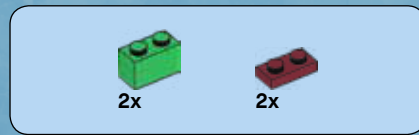
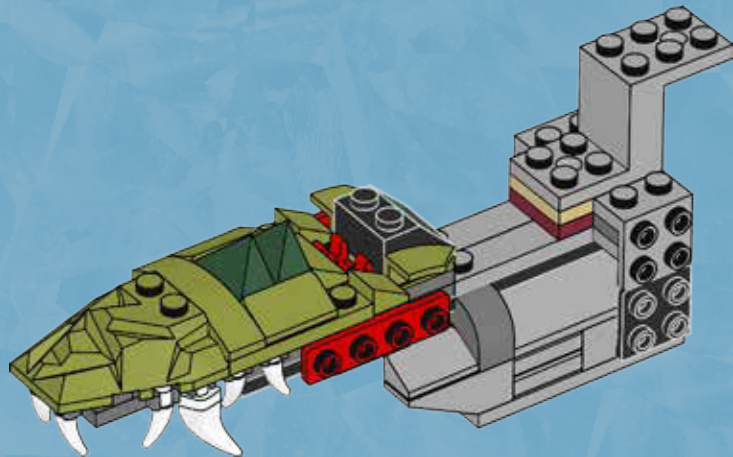

18

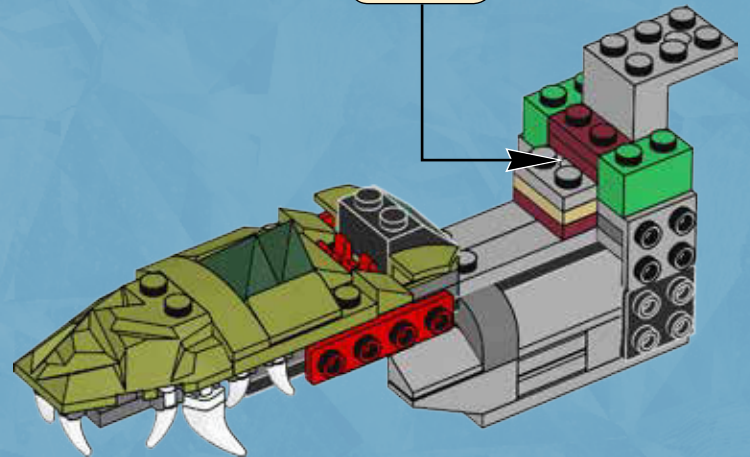
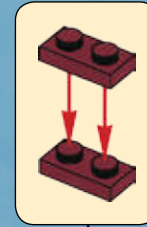



2x

19

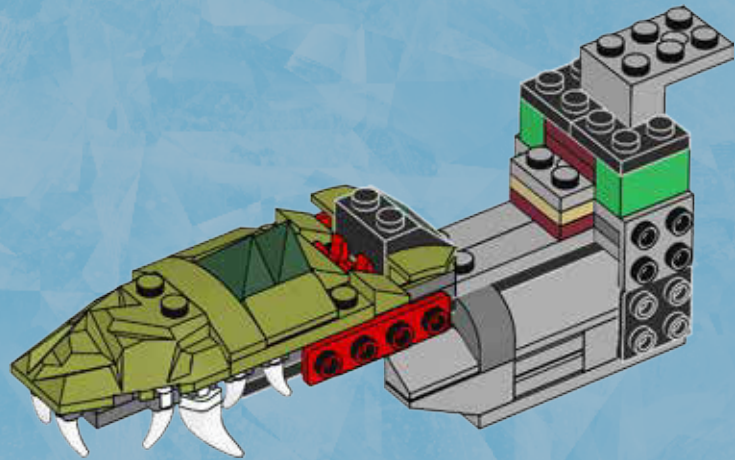

2x

20

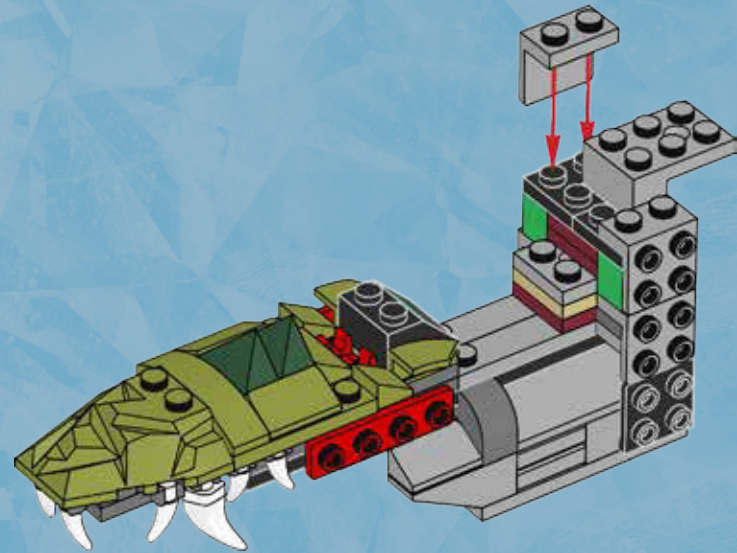



2x

21

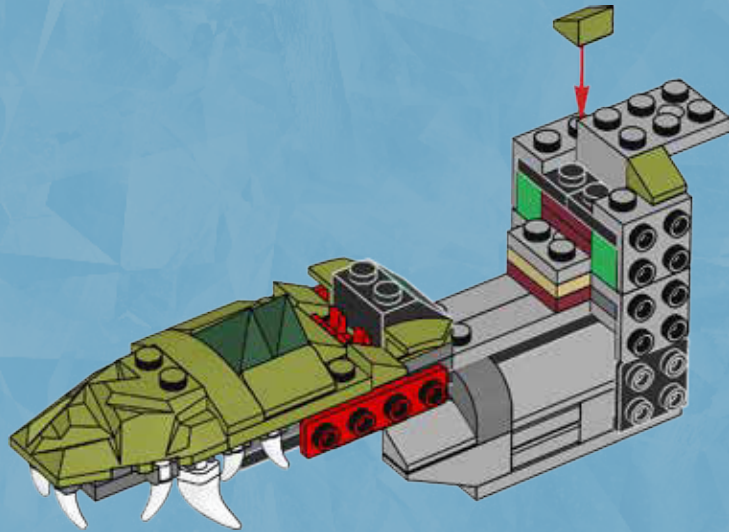

1x



2x

22

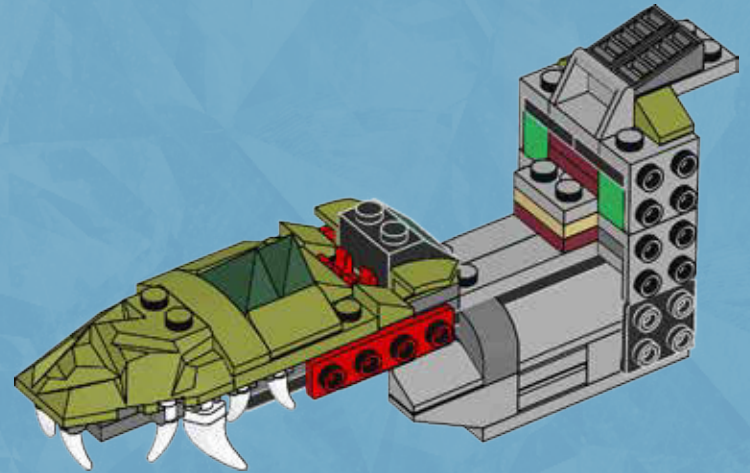



1x



1x

23

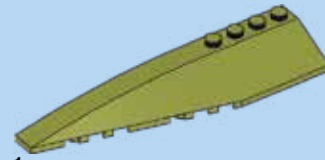
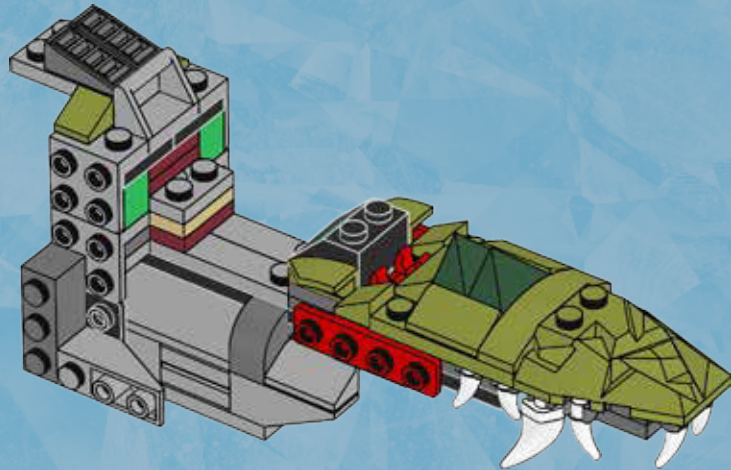

1x

24

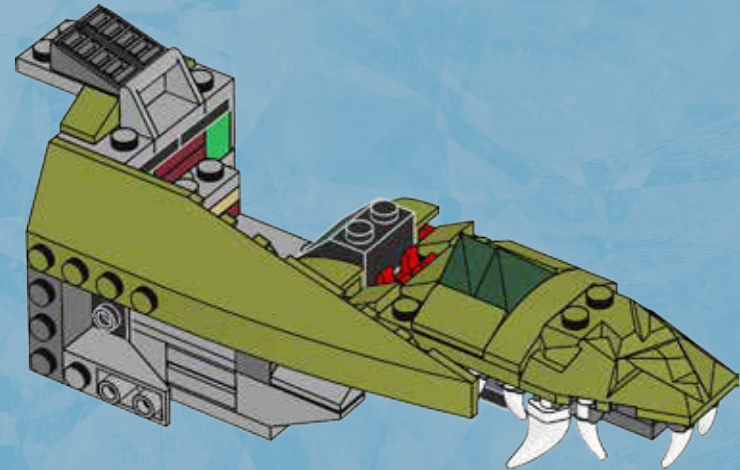



25

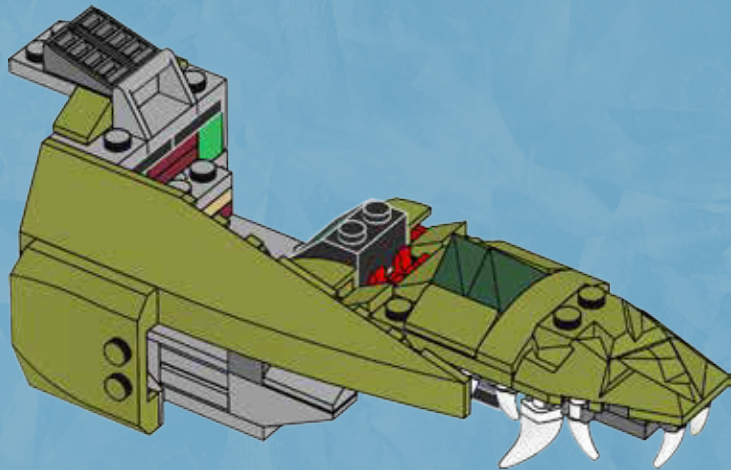

26

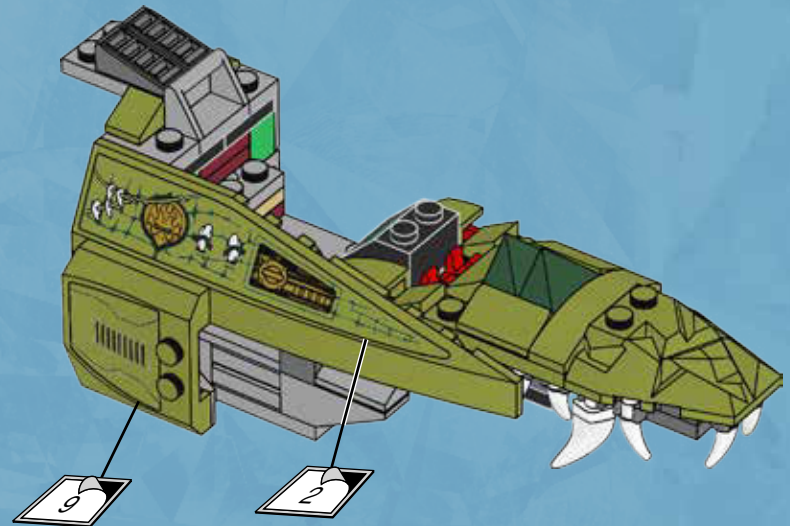



1x



1x

27

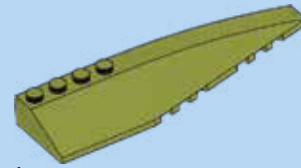
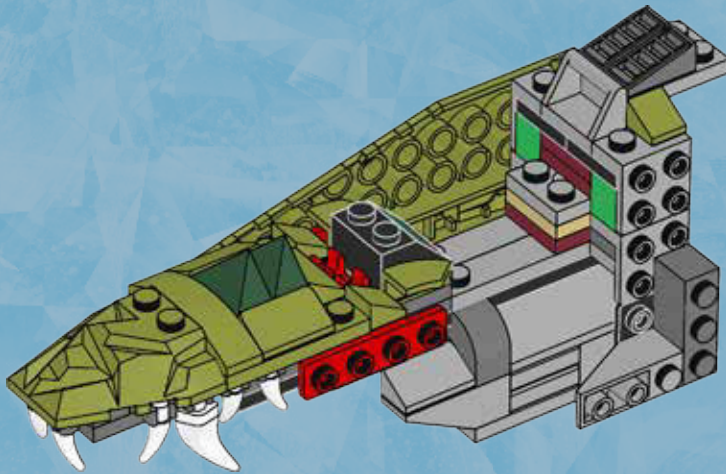

1x

28

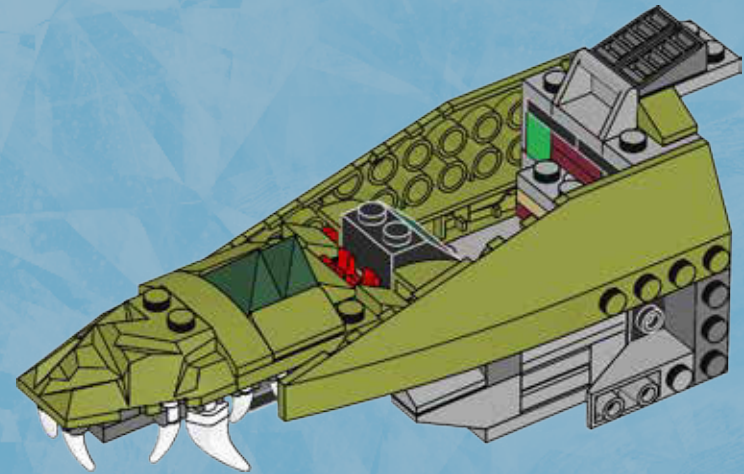



29

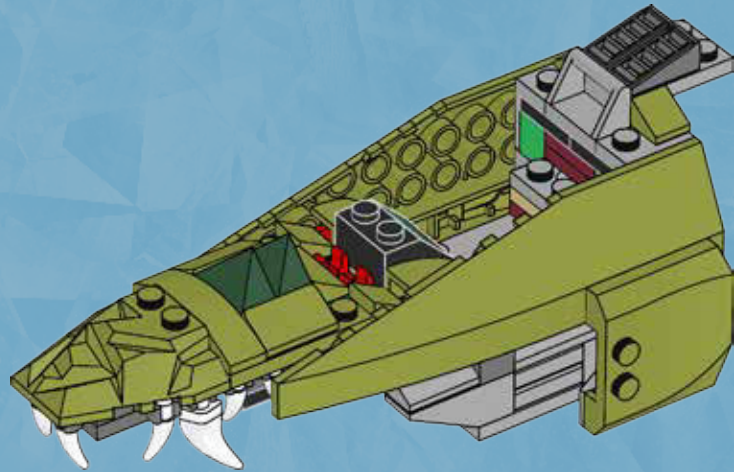

30

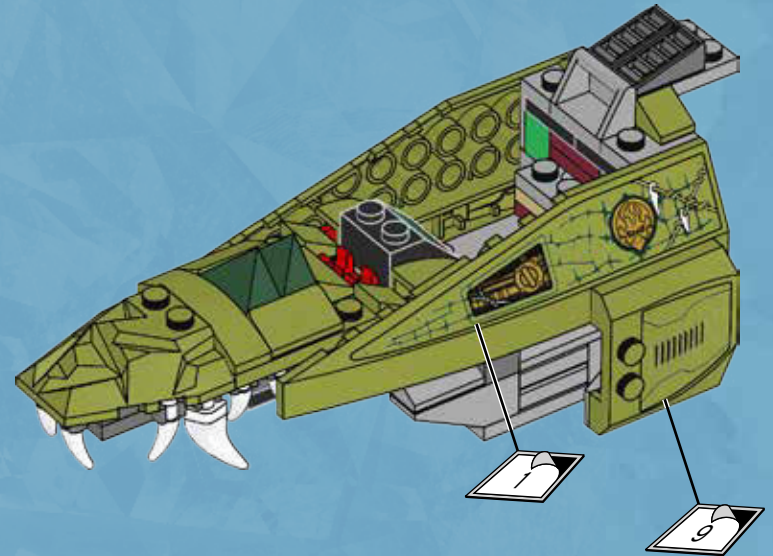

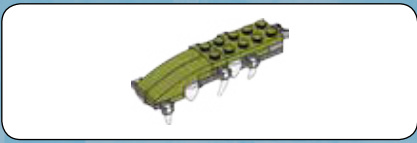

1

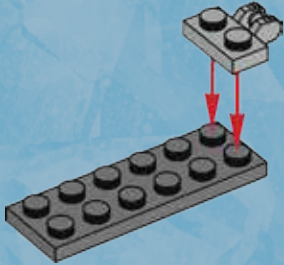

2

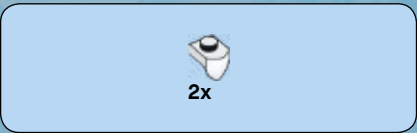
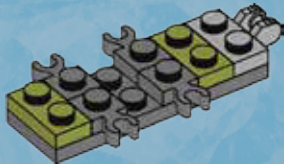

3

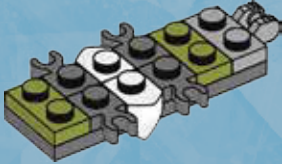

4

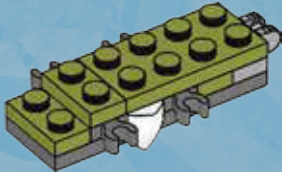

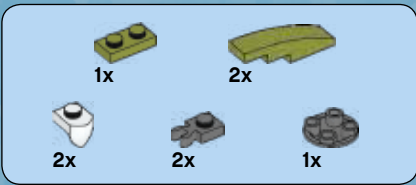

5

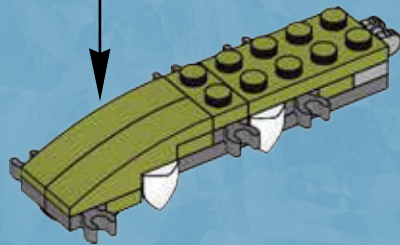
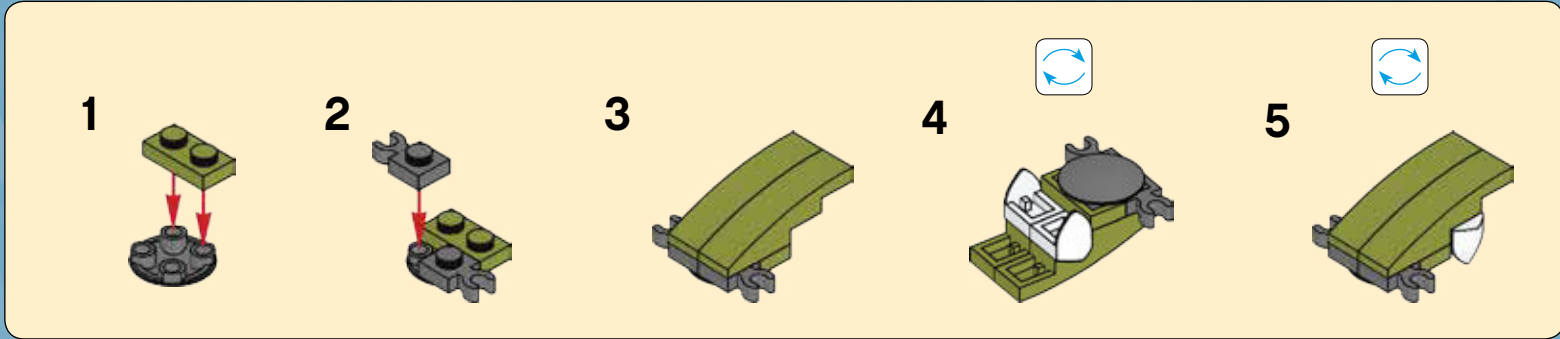



6

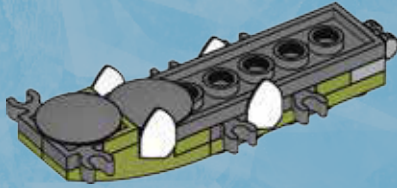

6x

7

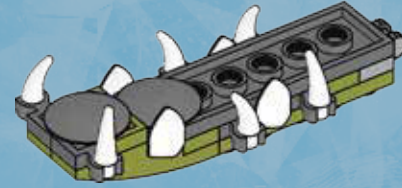

8

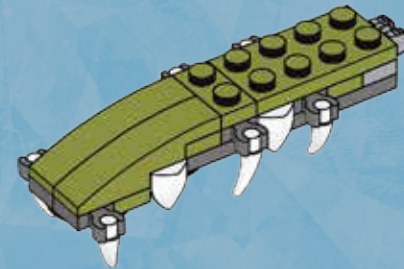

31

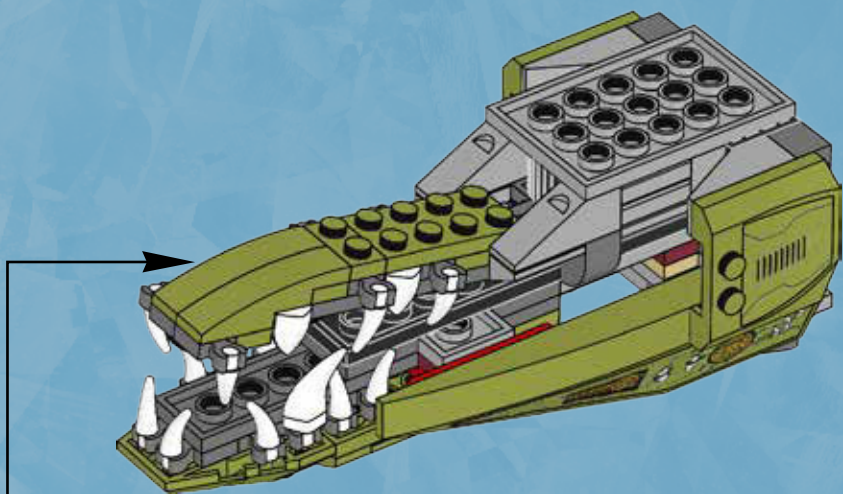

32

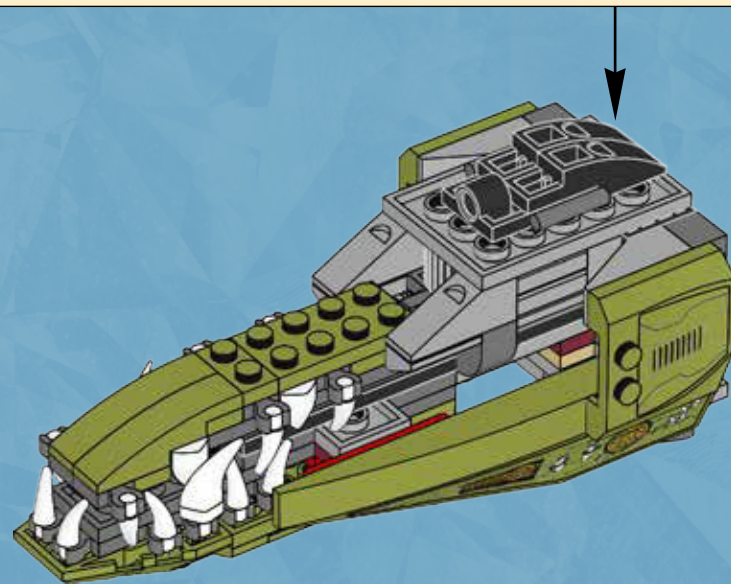



4x

33

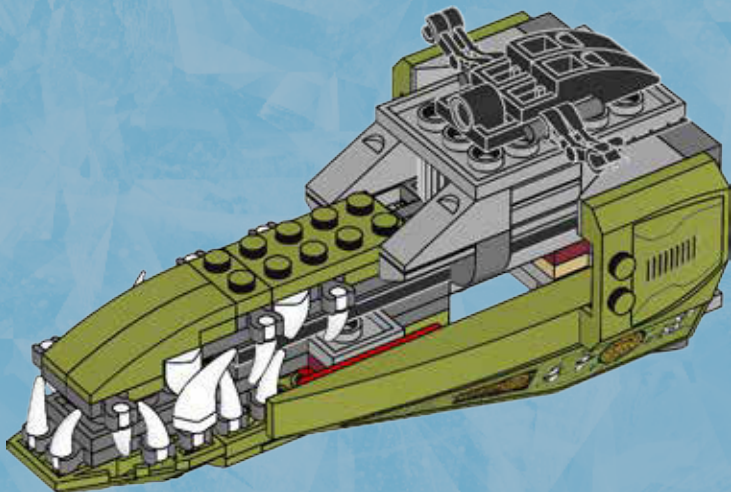

1x

34

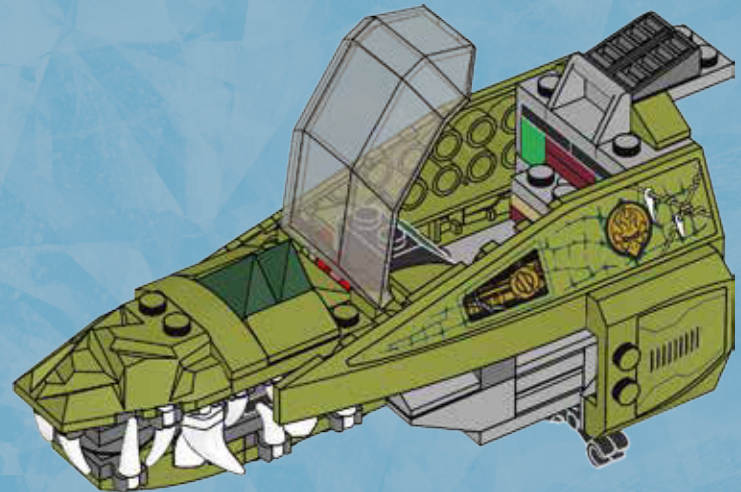

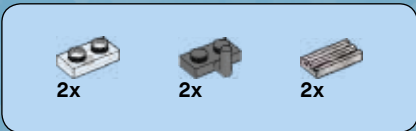

35

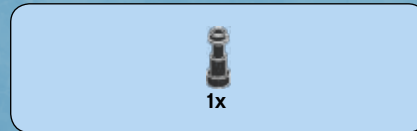
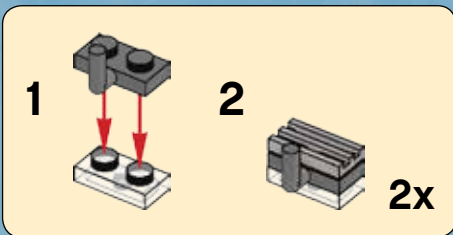
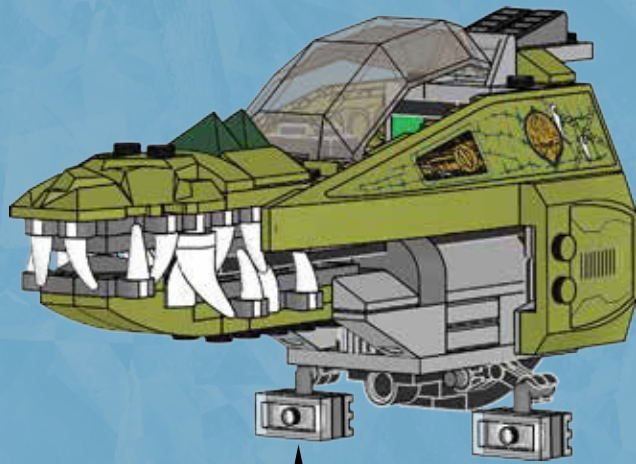

36

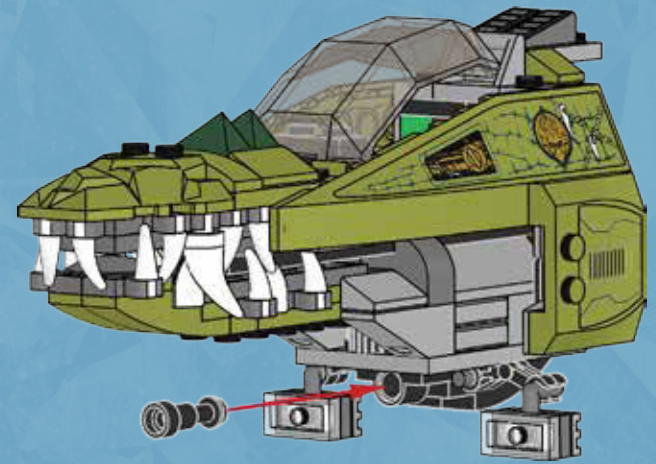

37

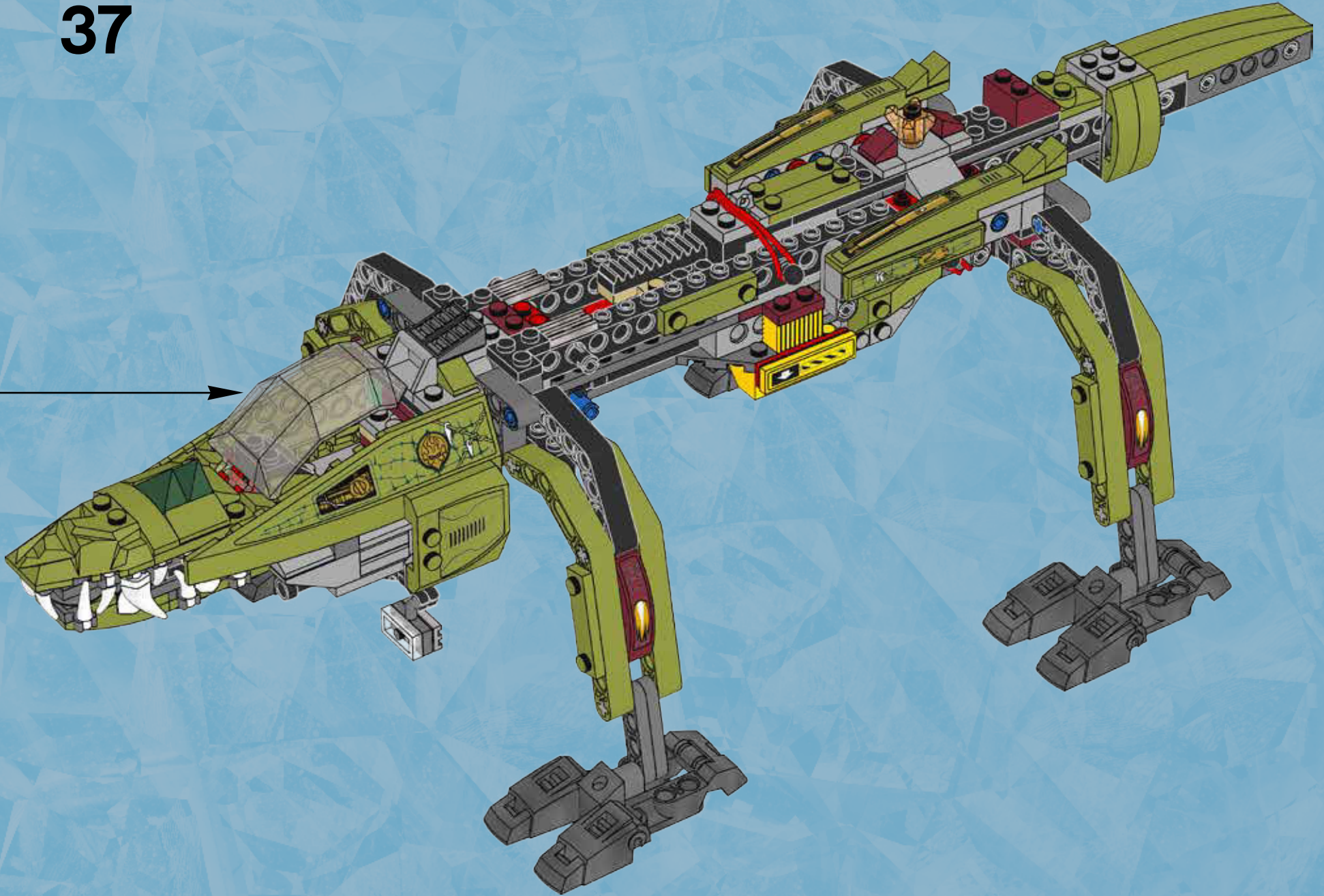

38

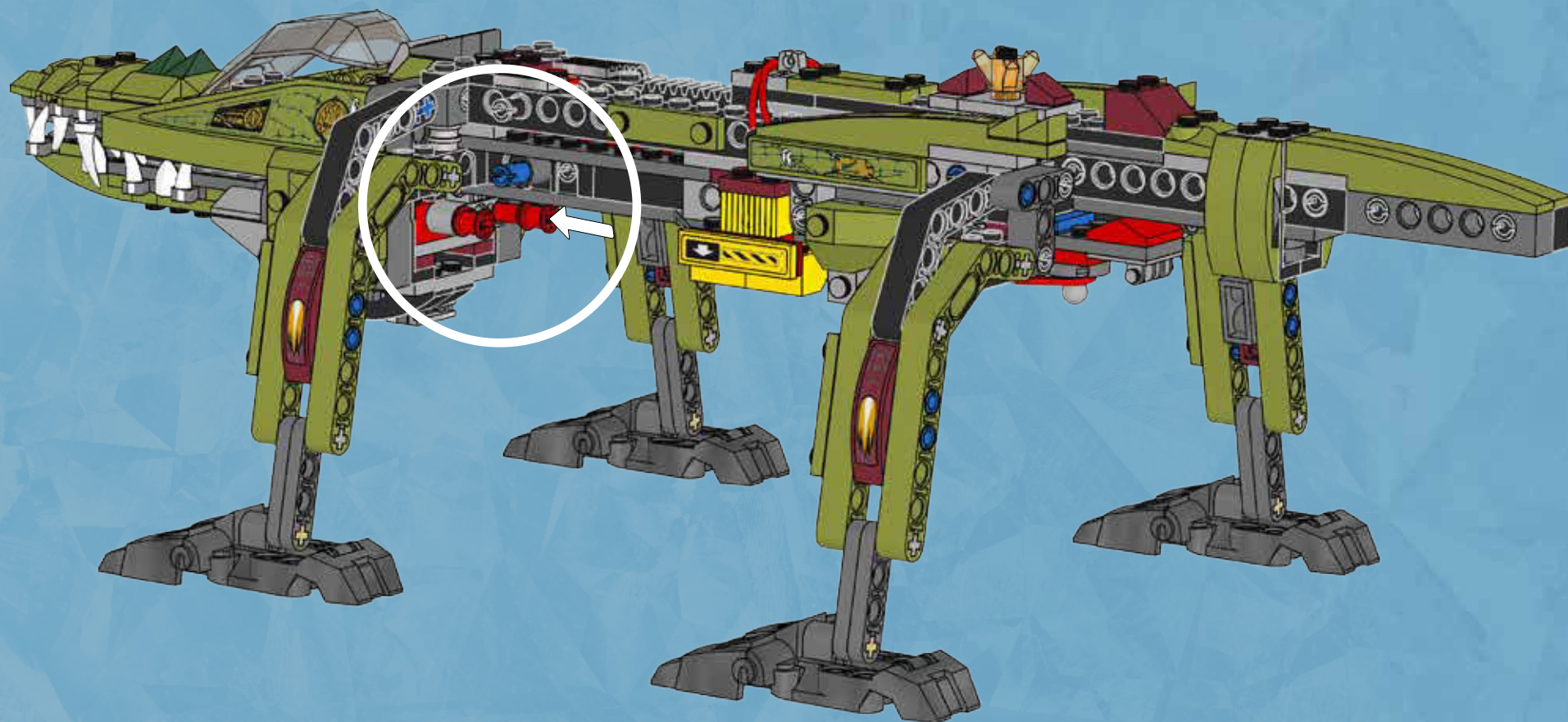



1x

39

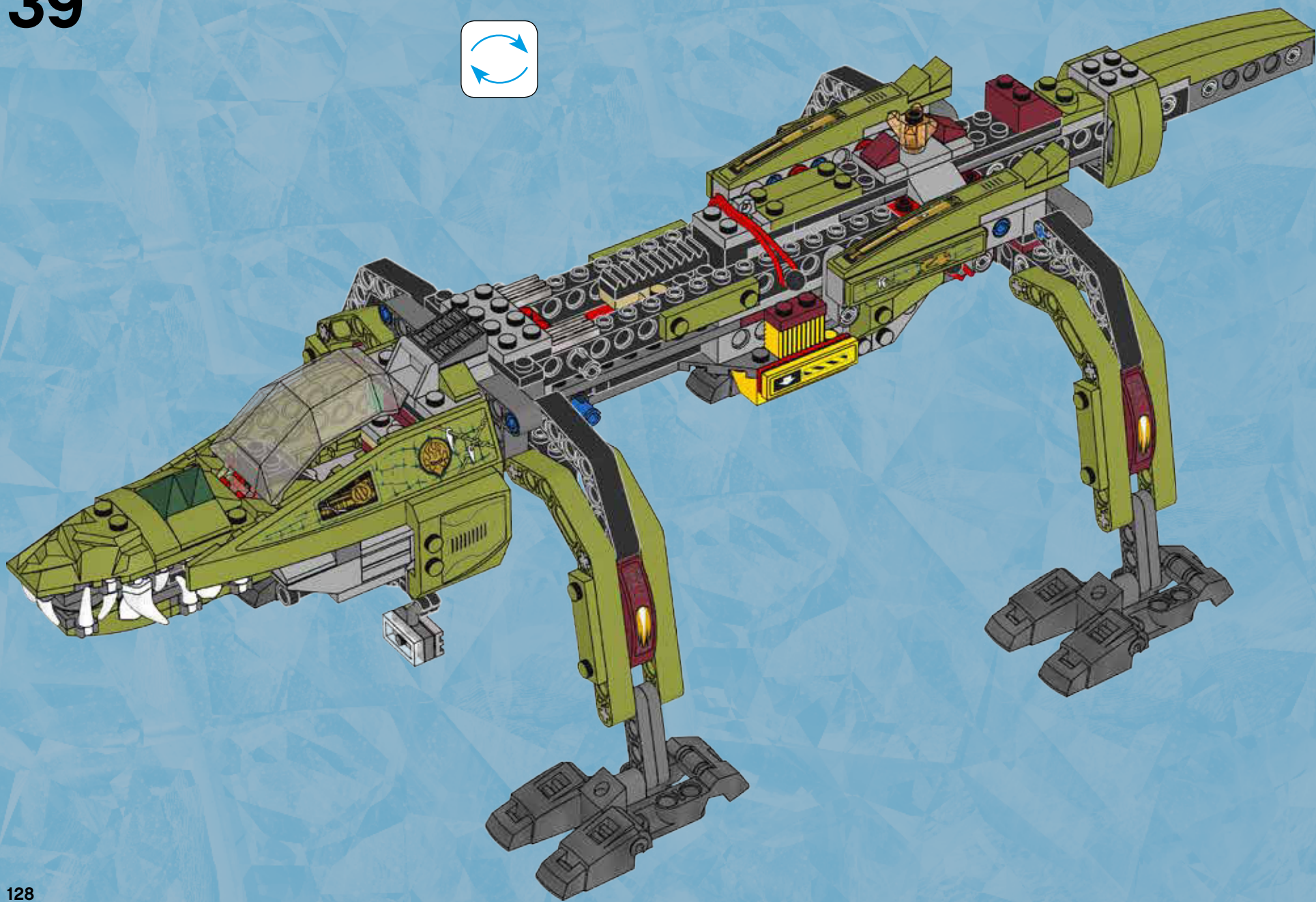



2x

40

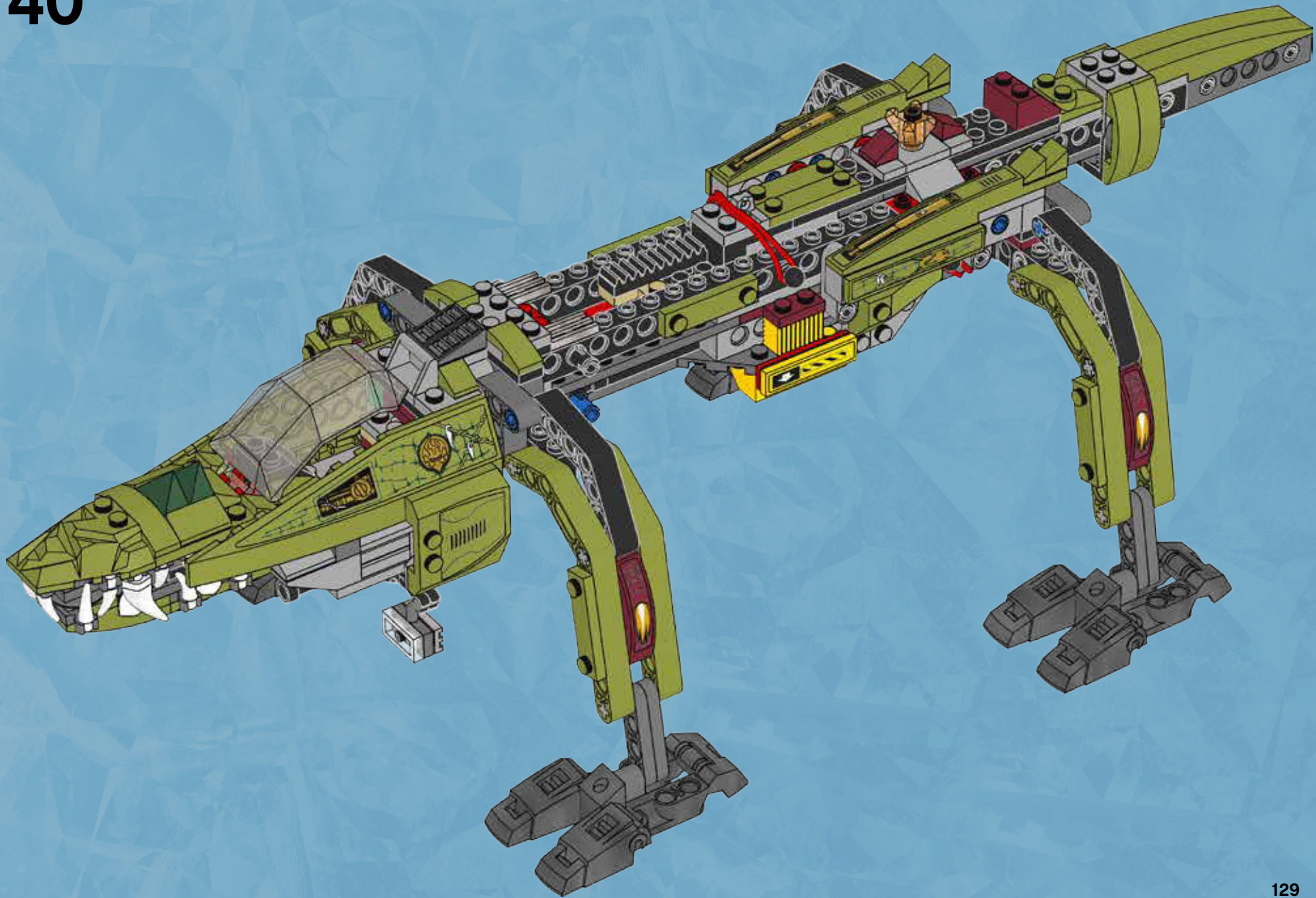



1x

41

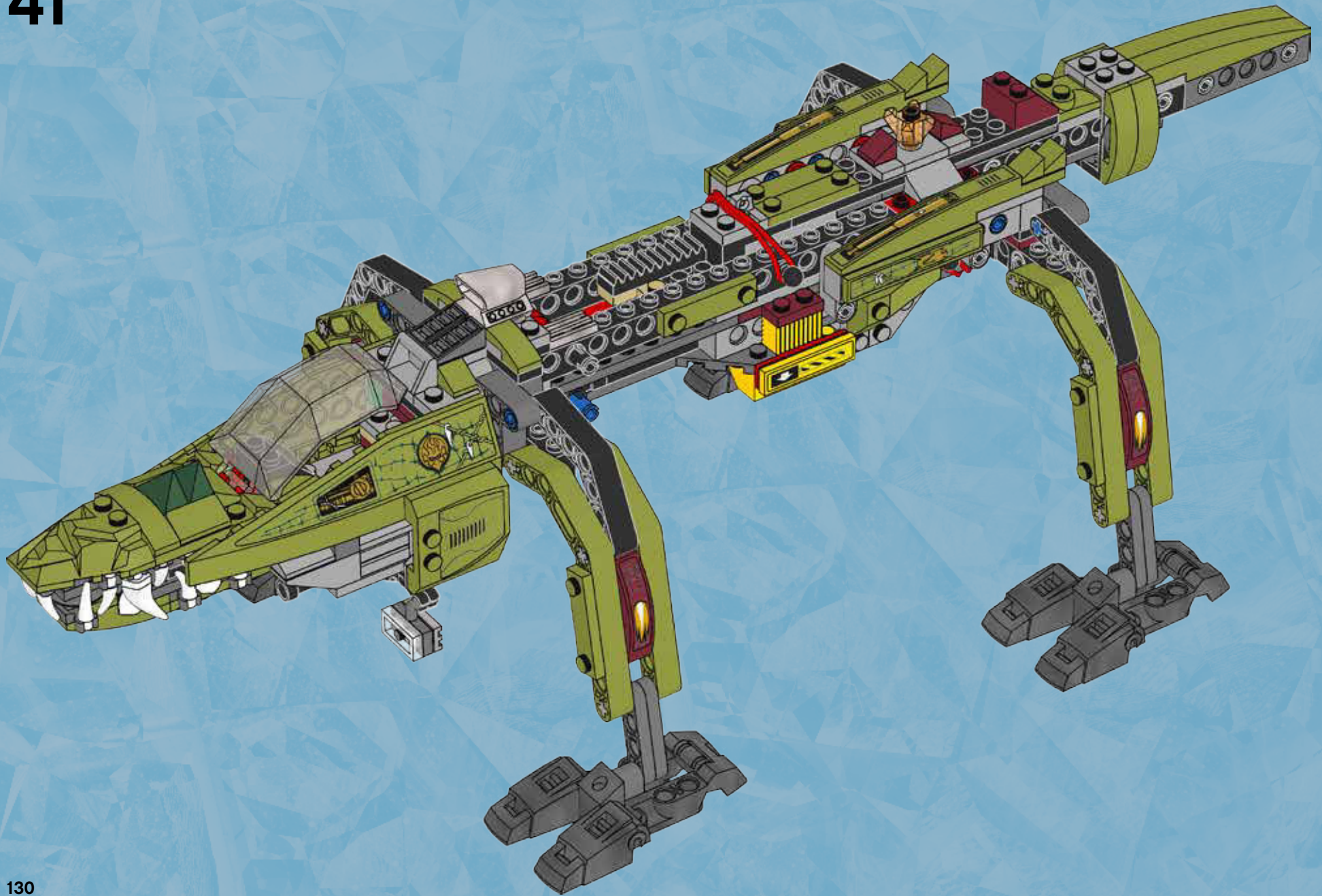

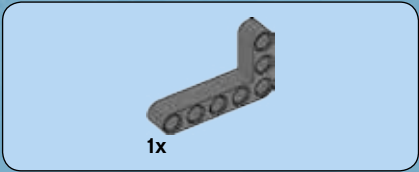
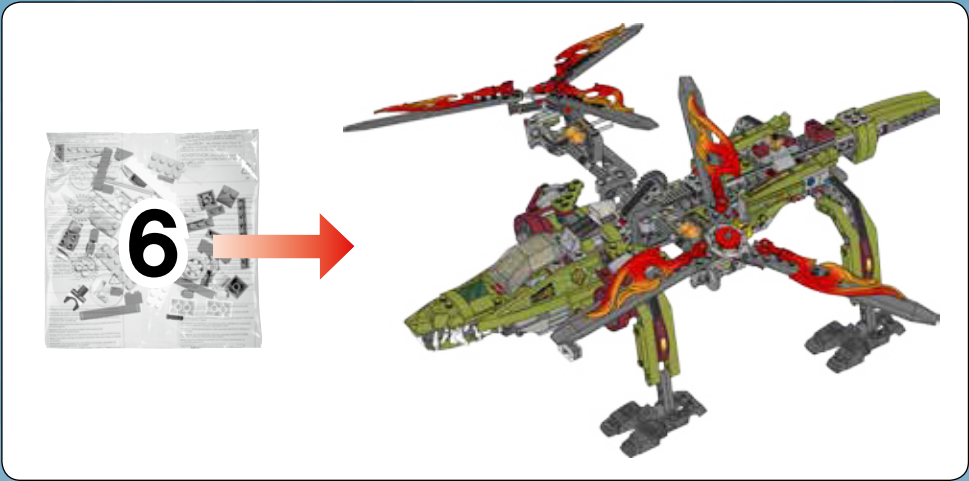

42

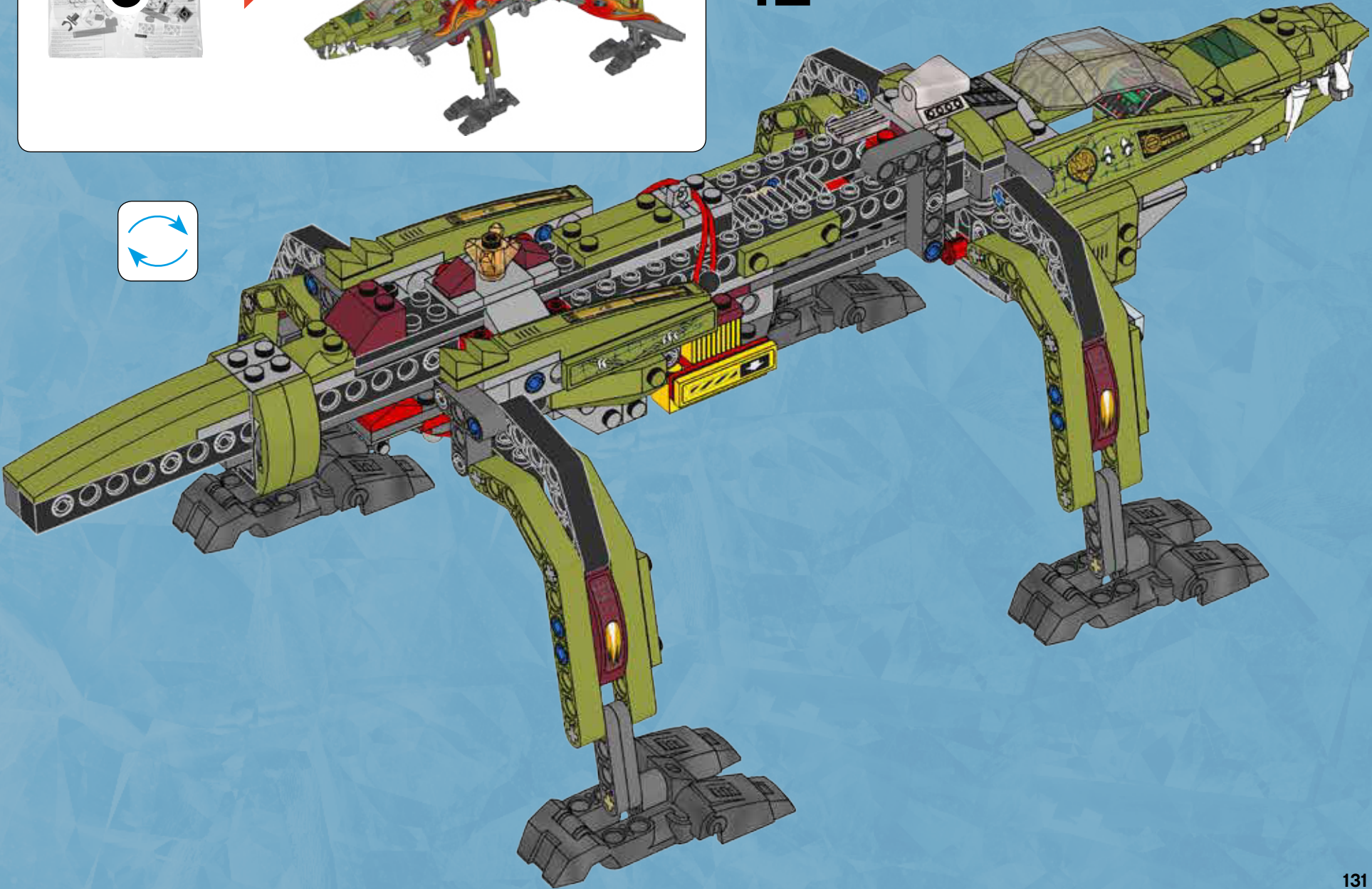



1x

43

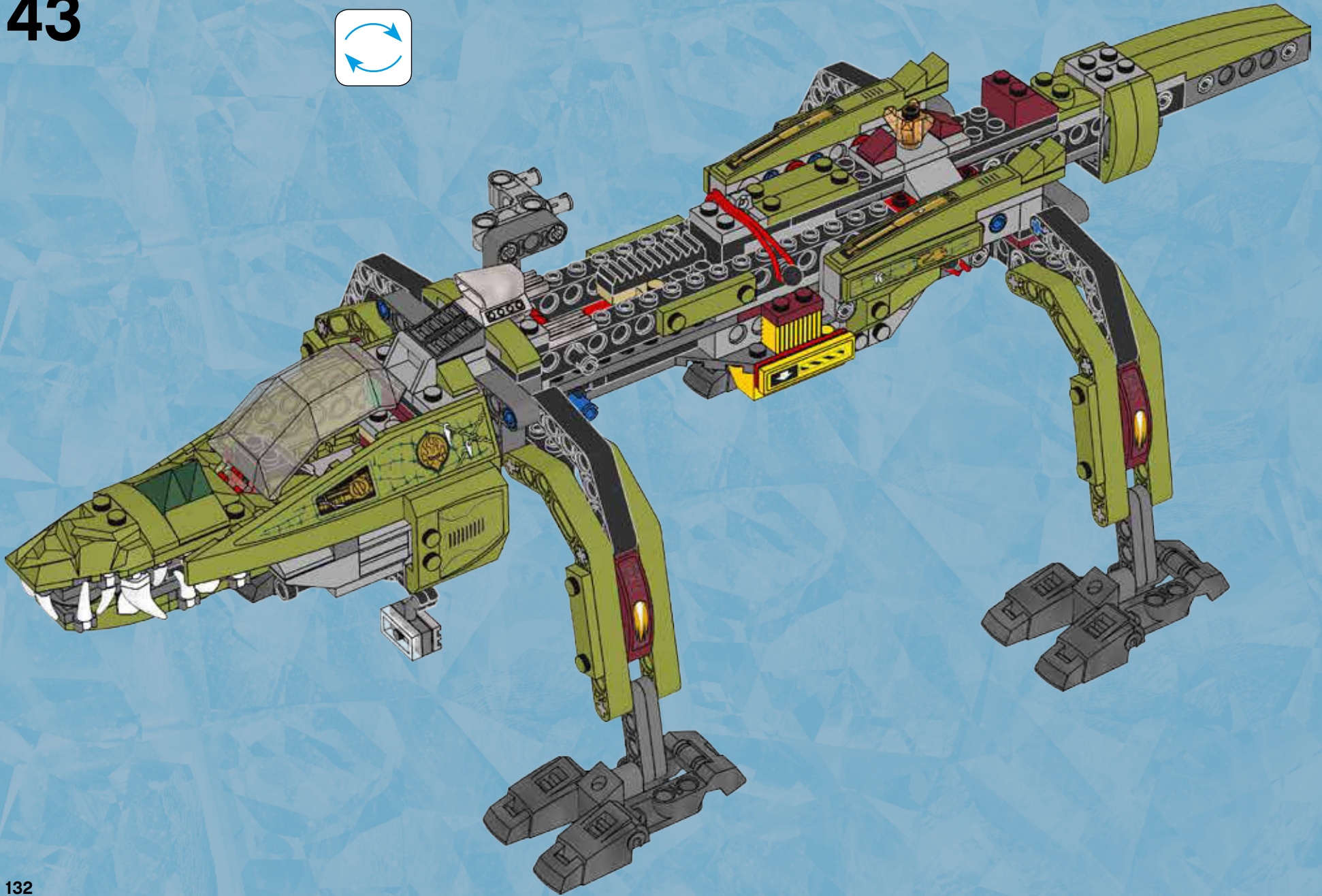

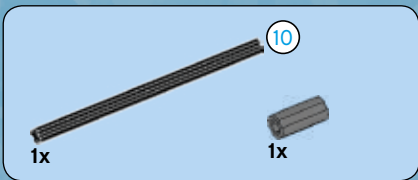

44

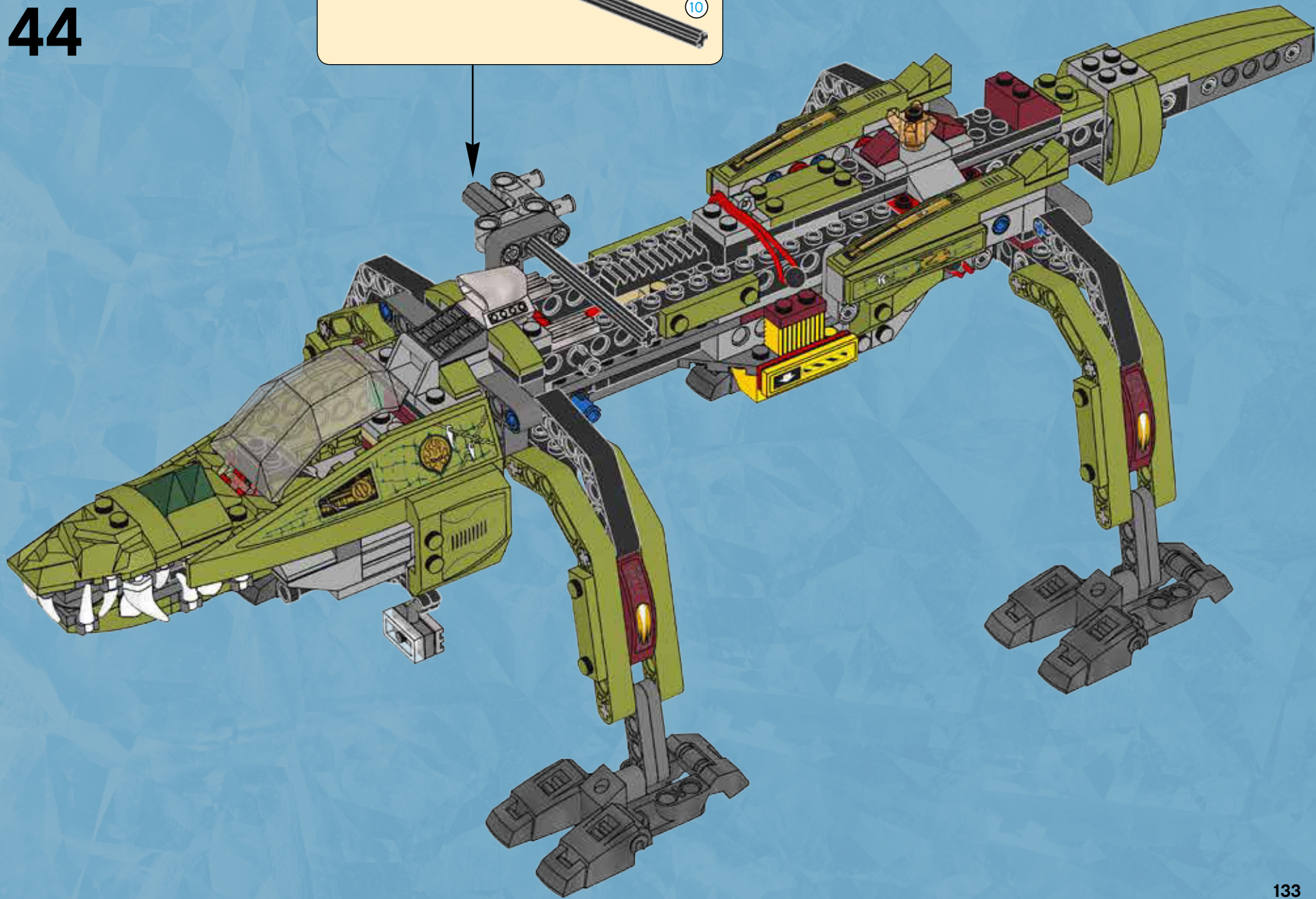
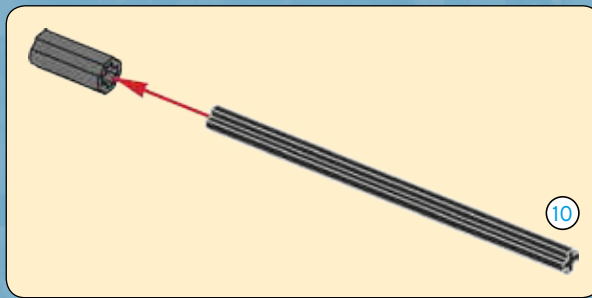



1x



1x

45

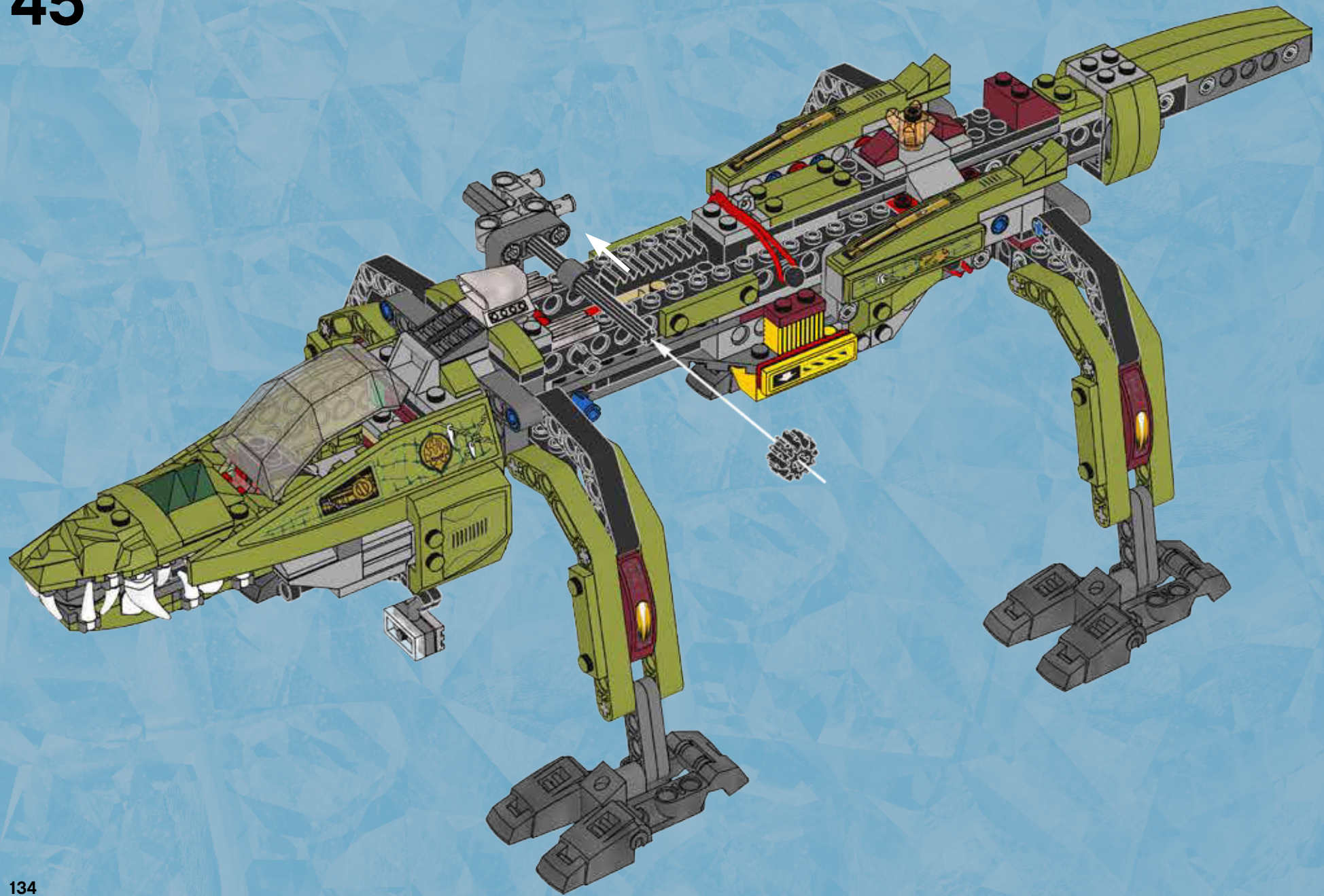

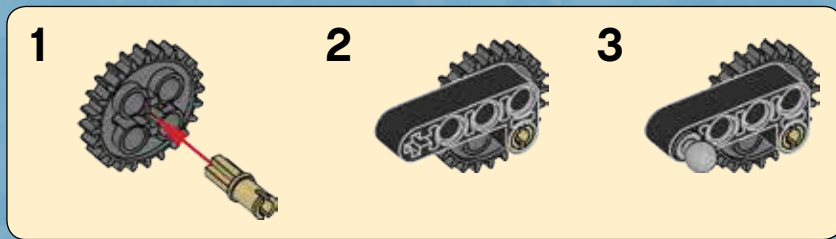
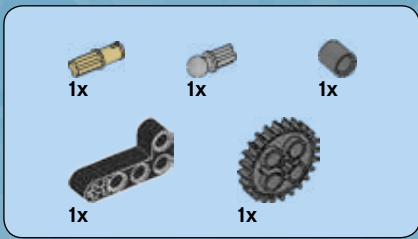

46

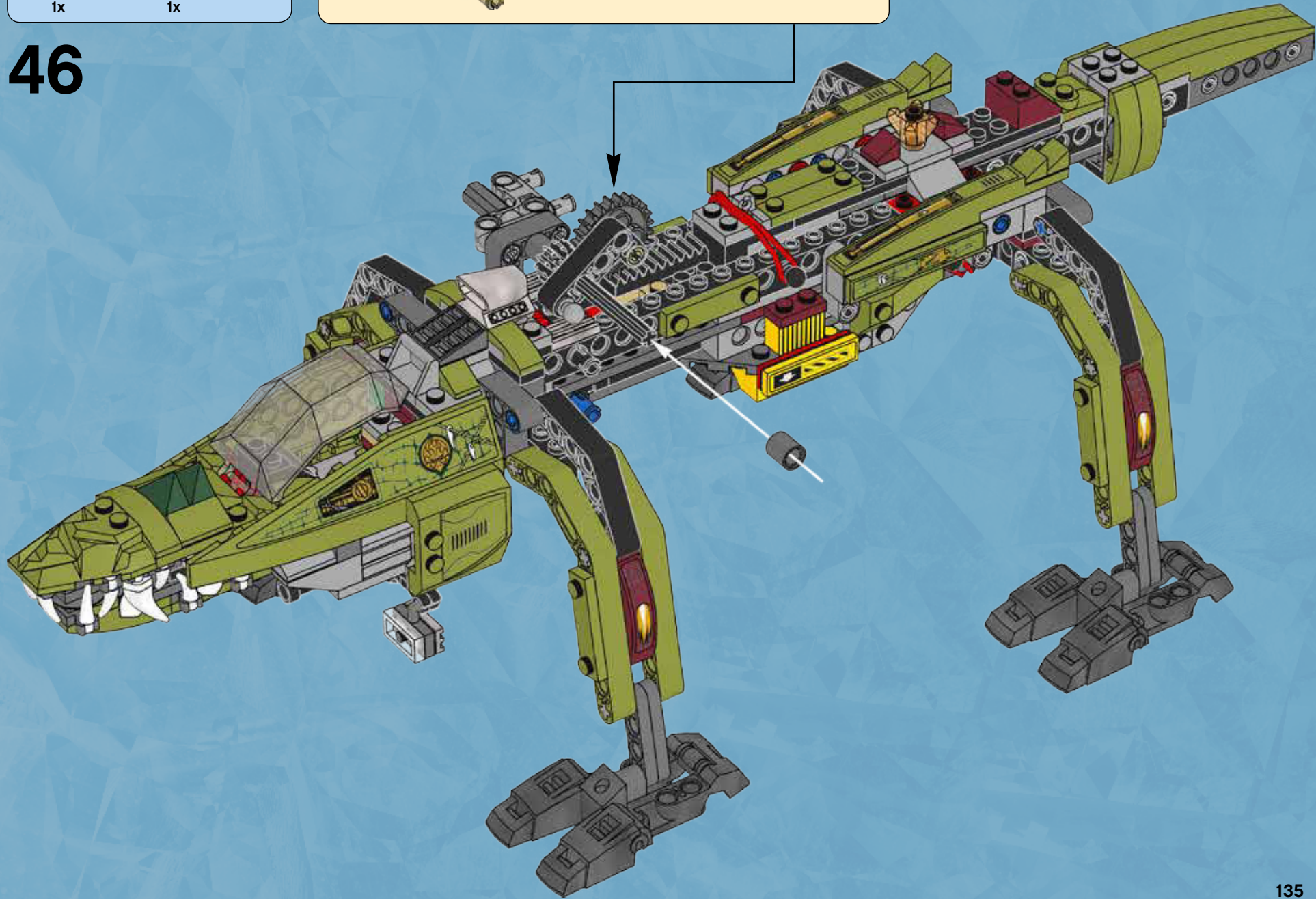

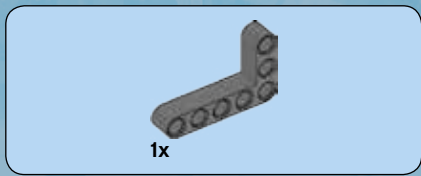

47

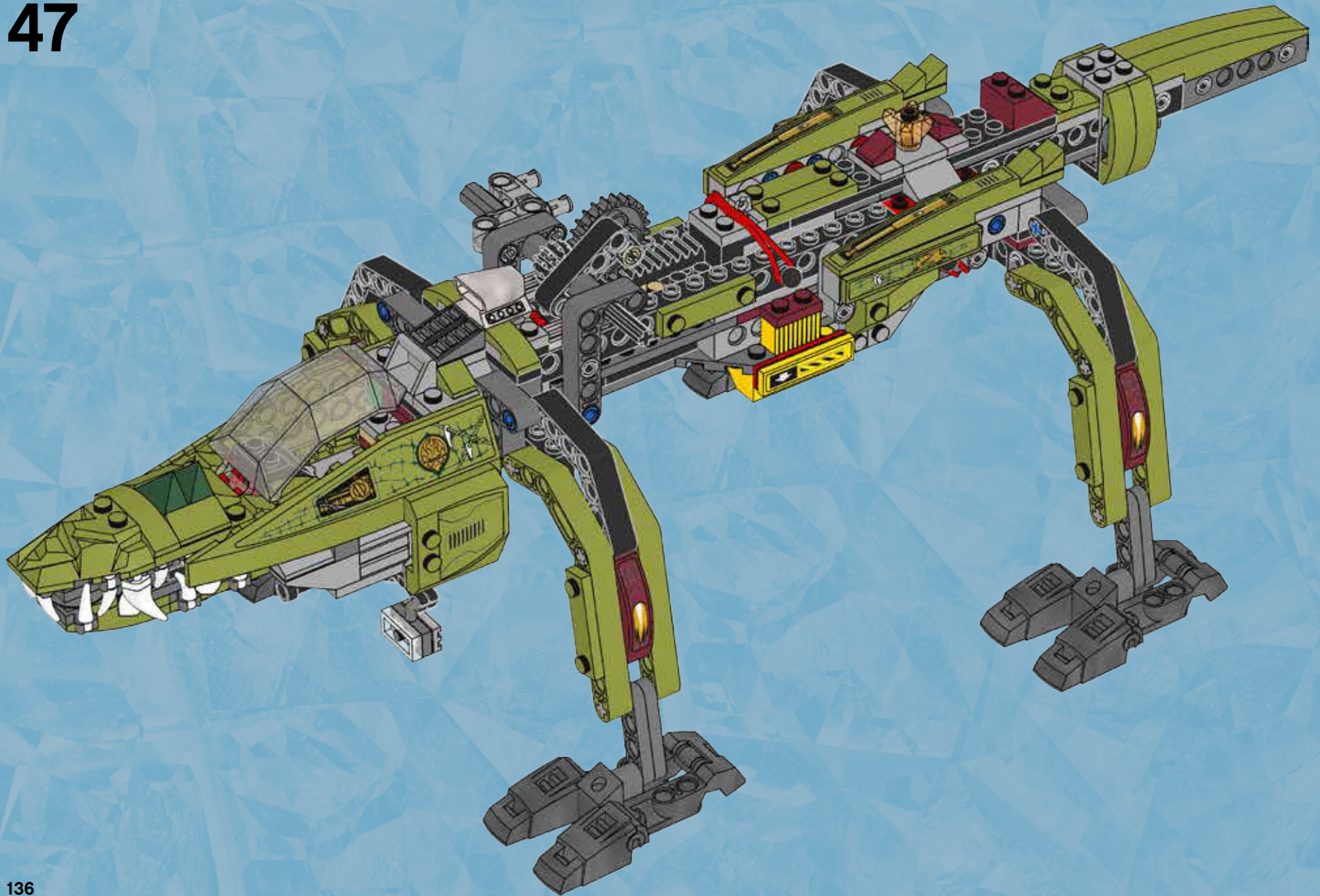

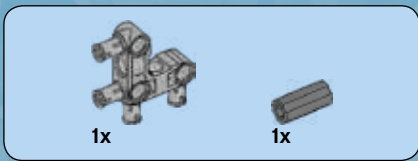

48

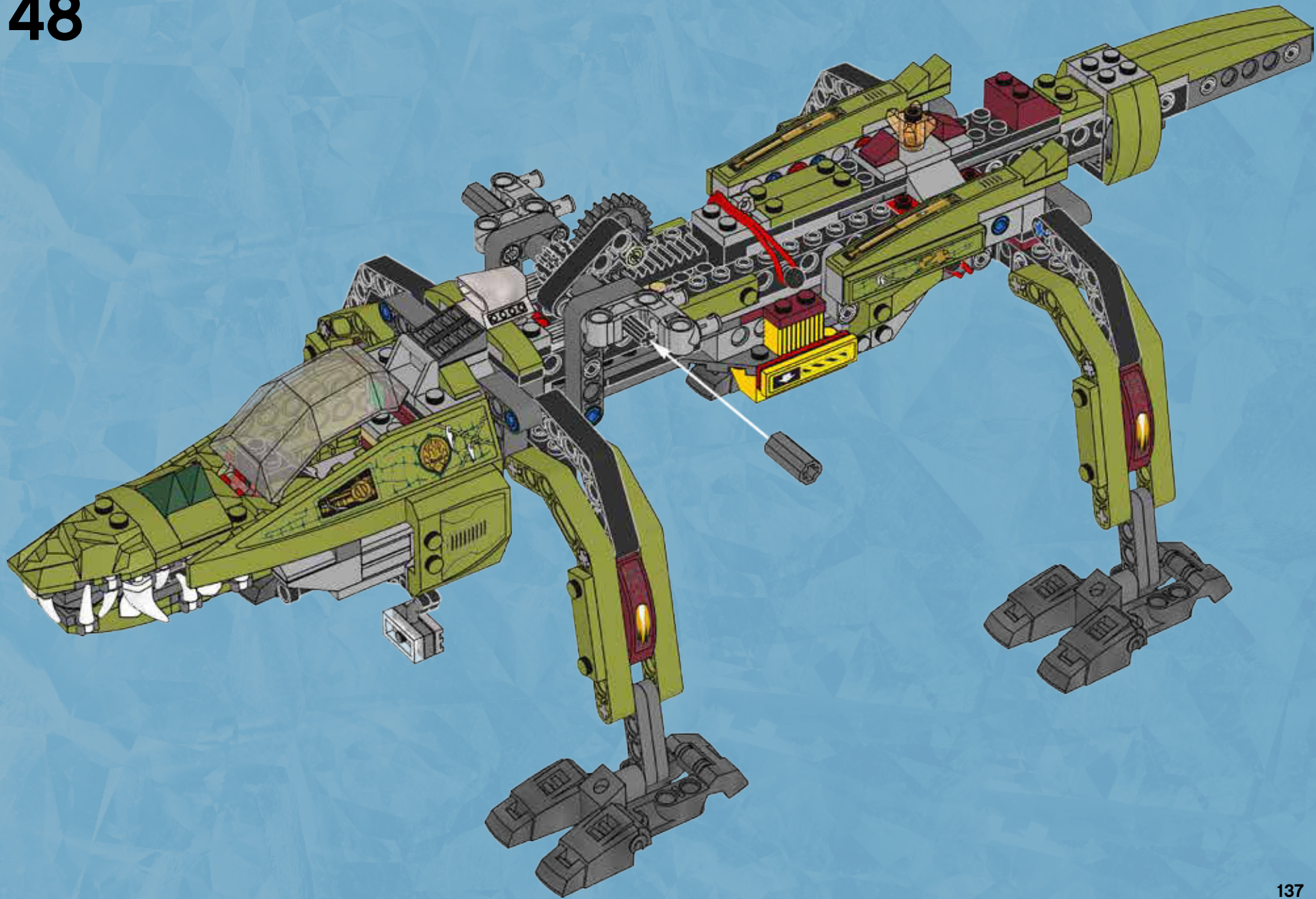

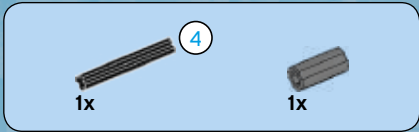
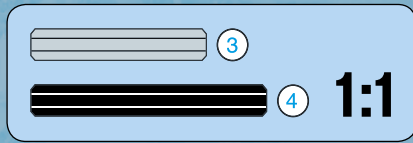

1

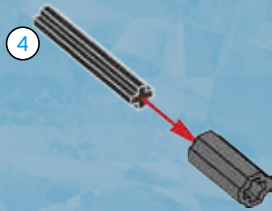

2

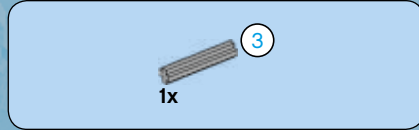
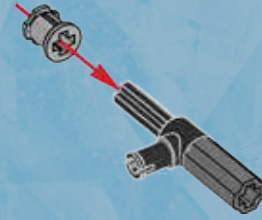

3

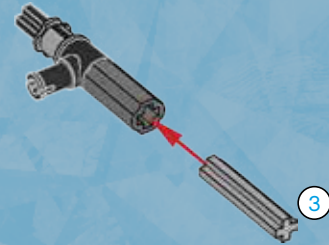



4

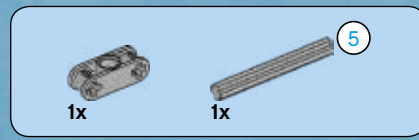
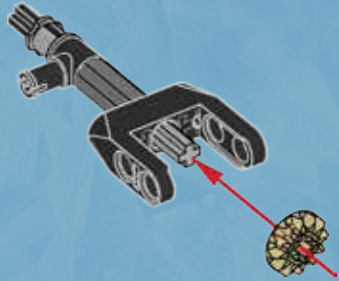

5

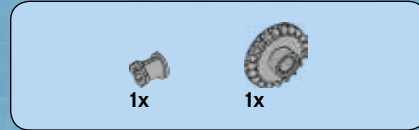
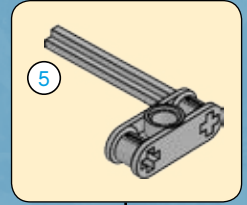

6

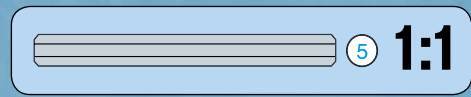
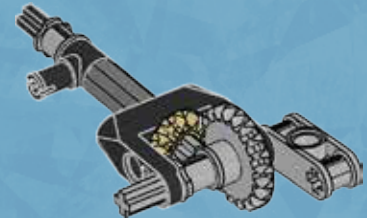

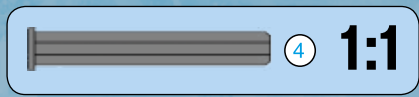

7

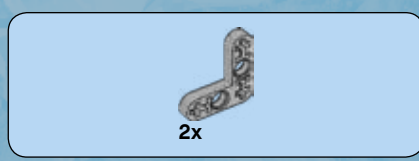
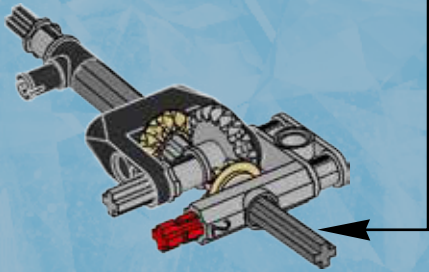
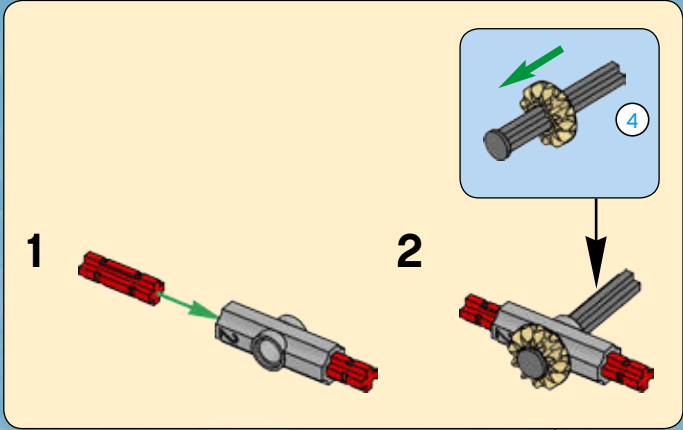

8

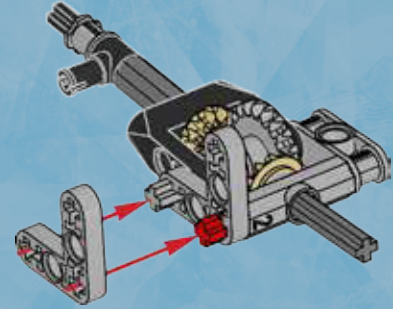

9

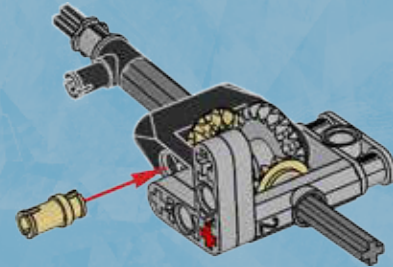



10

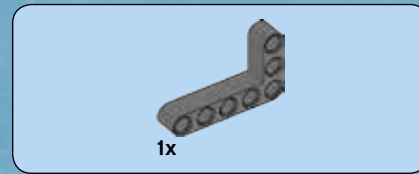
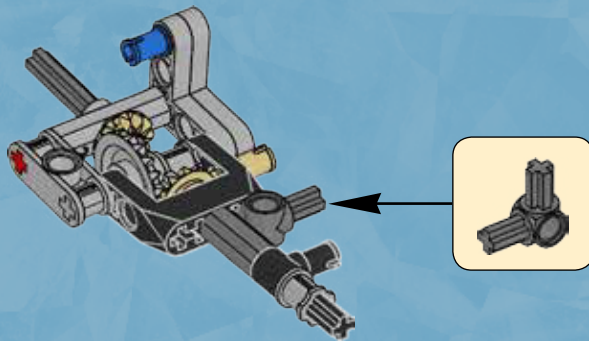

11

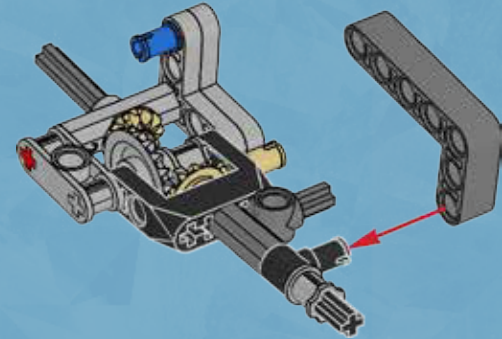

12

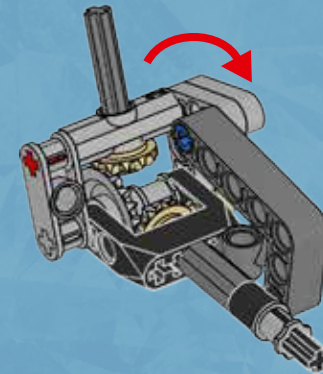

49

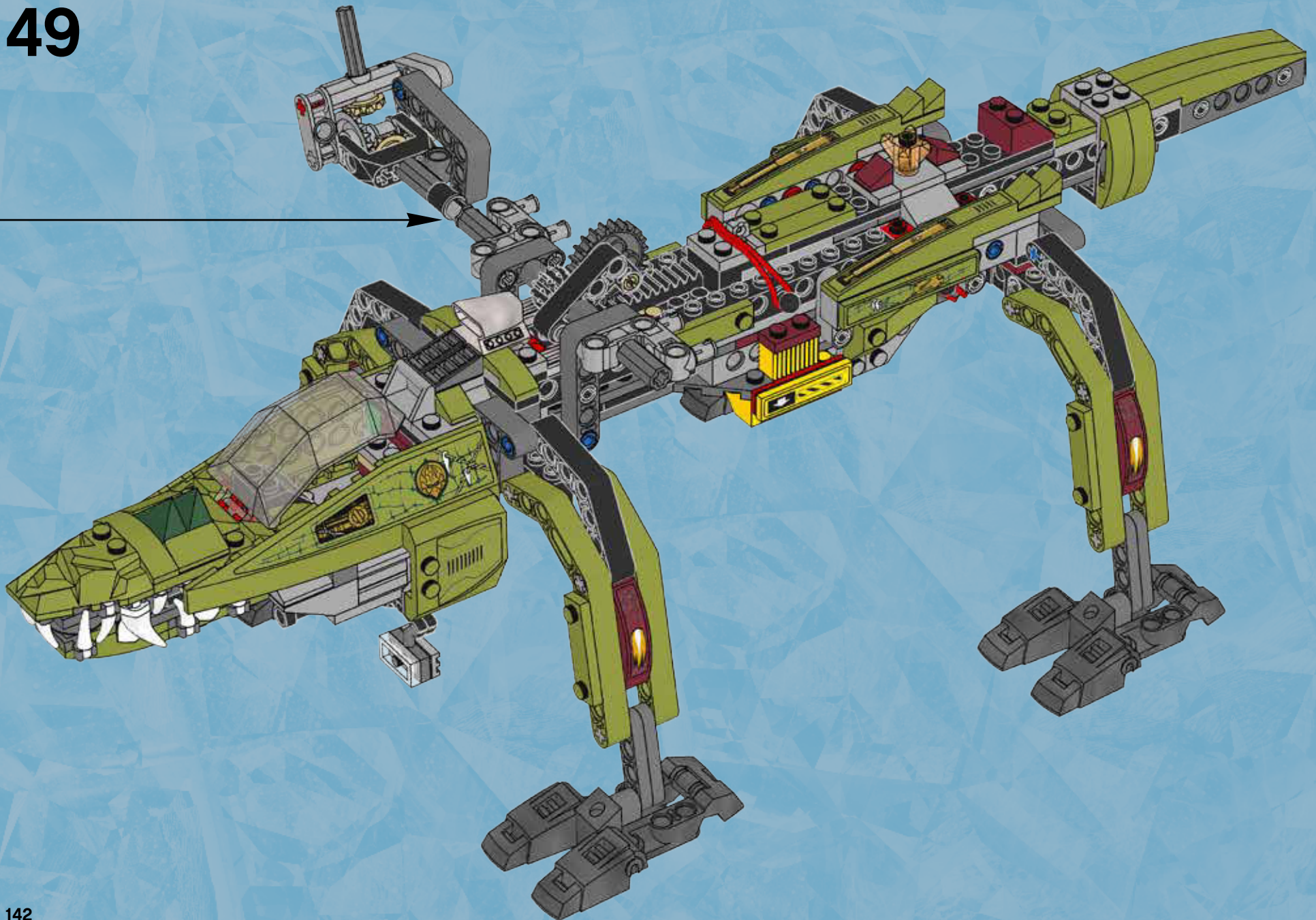

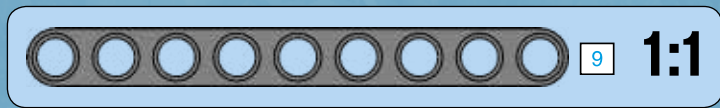
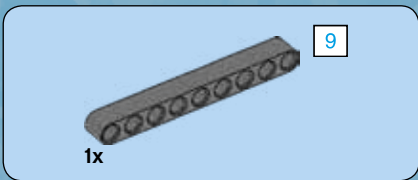

50

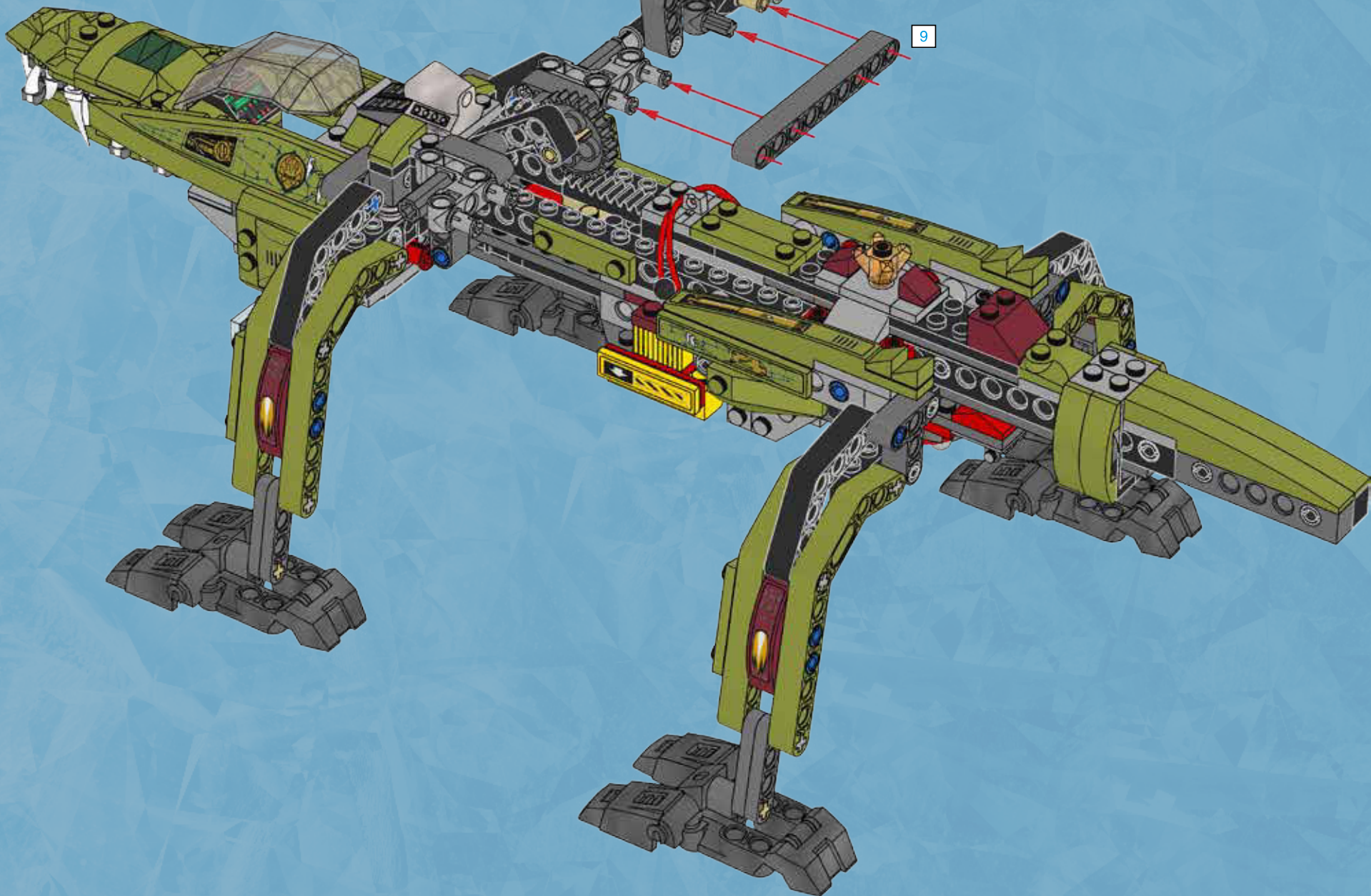

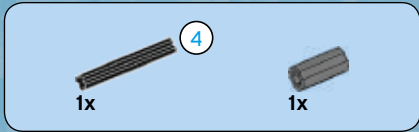
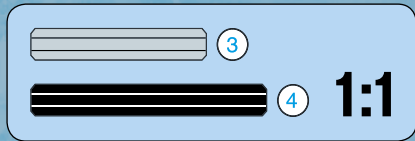

1

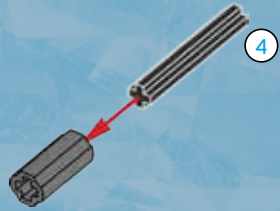

2

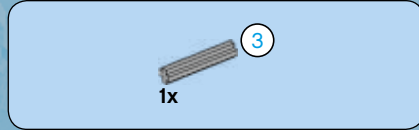

3

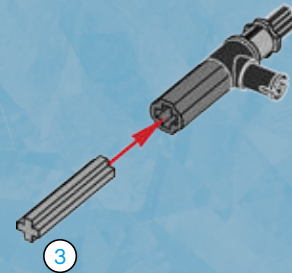



4

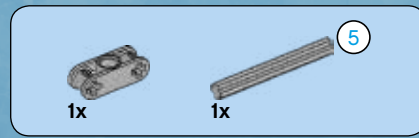
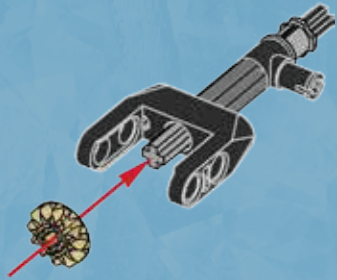

5

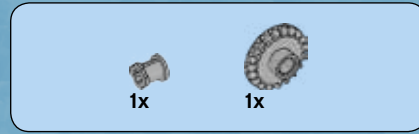
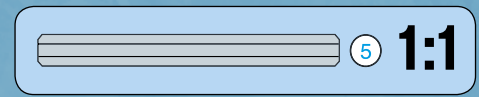
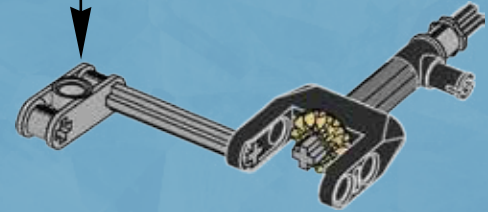
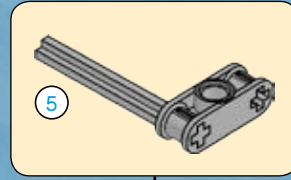

6

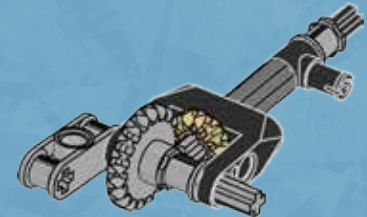

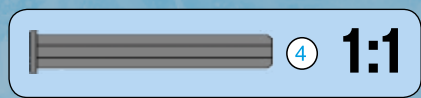

7

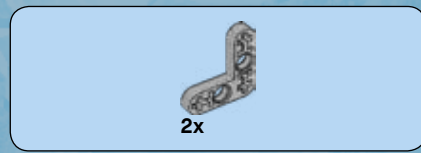
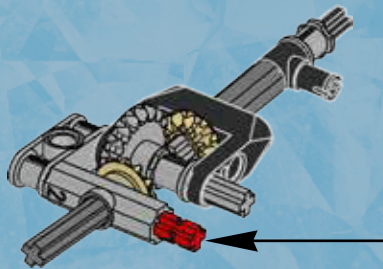
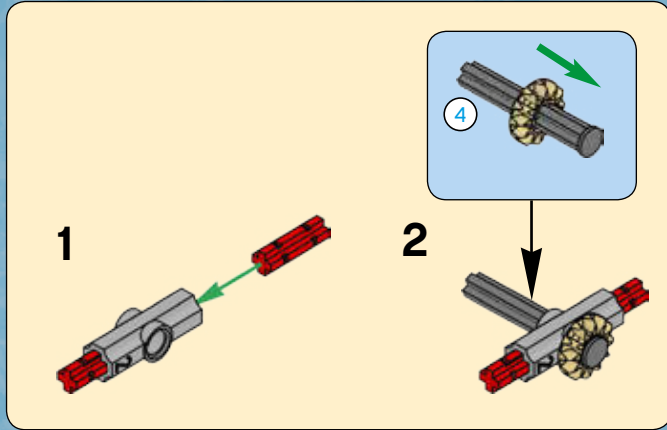

8

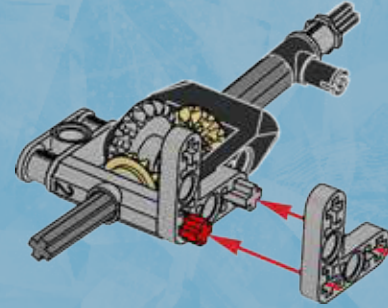

9

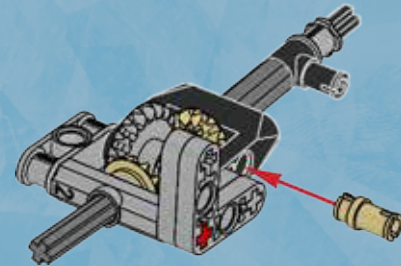



10

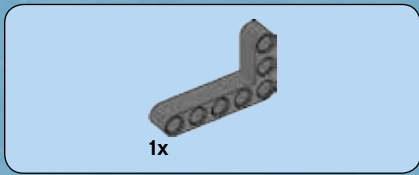
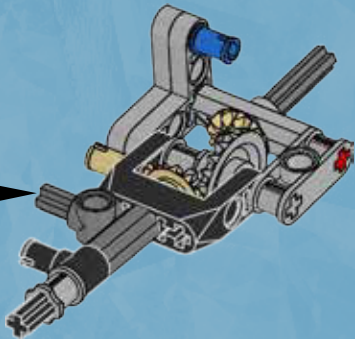
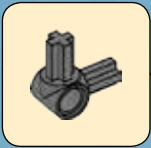

11

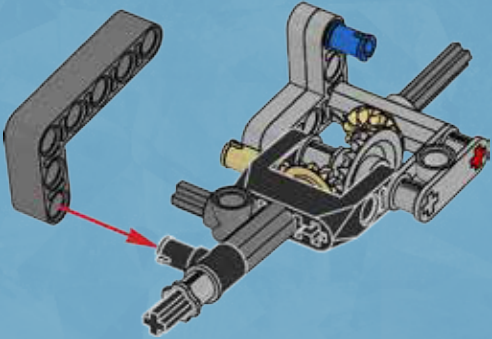

12

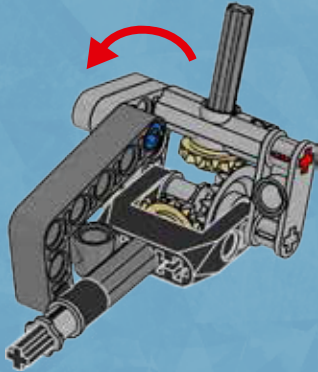

51

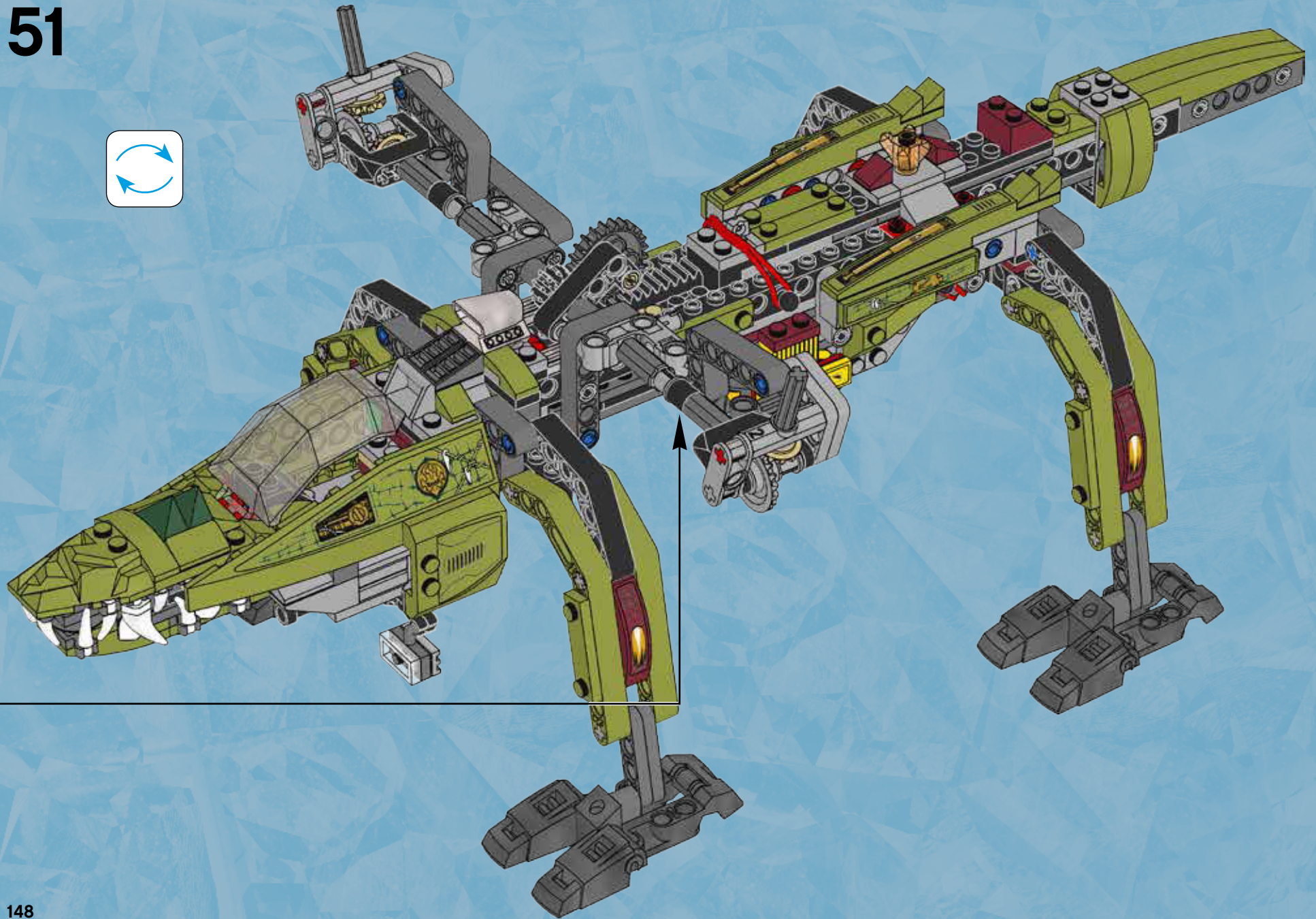

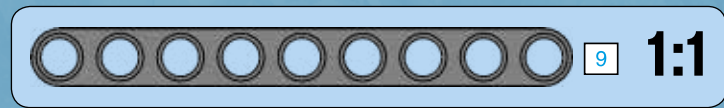
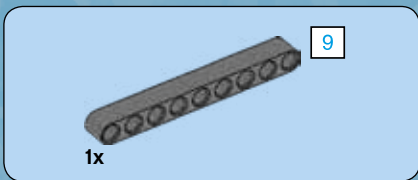

52

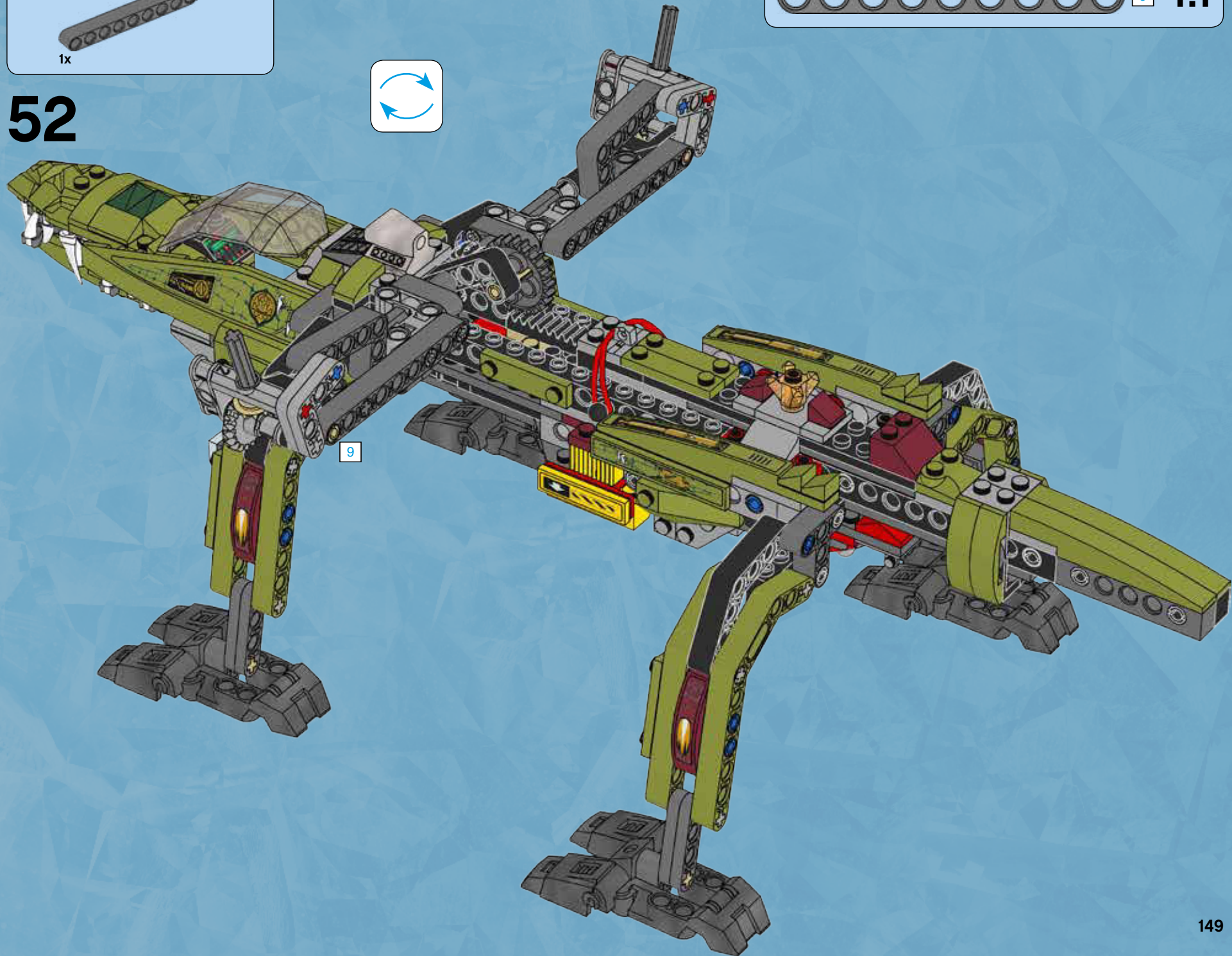
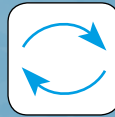



53

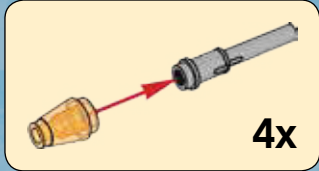
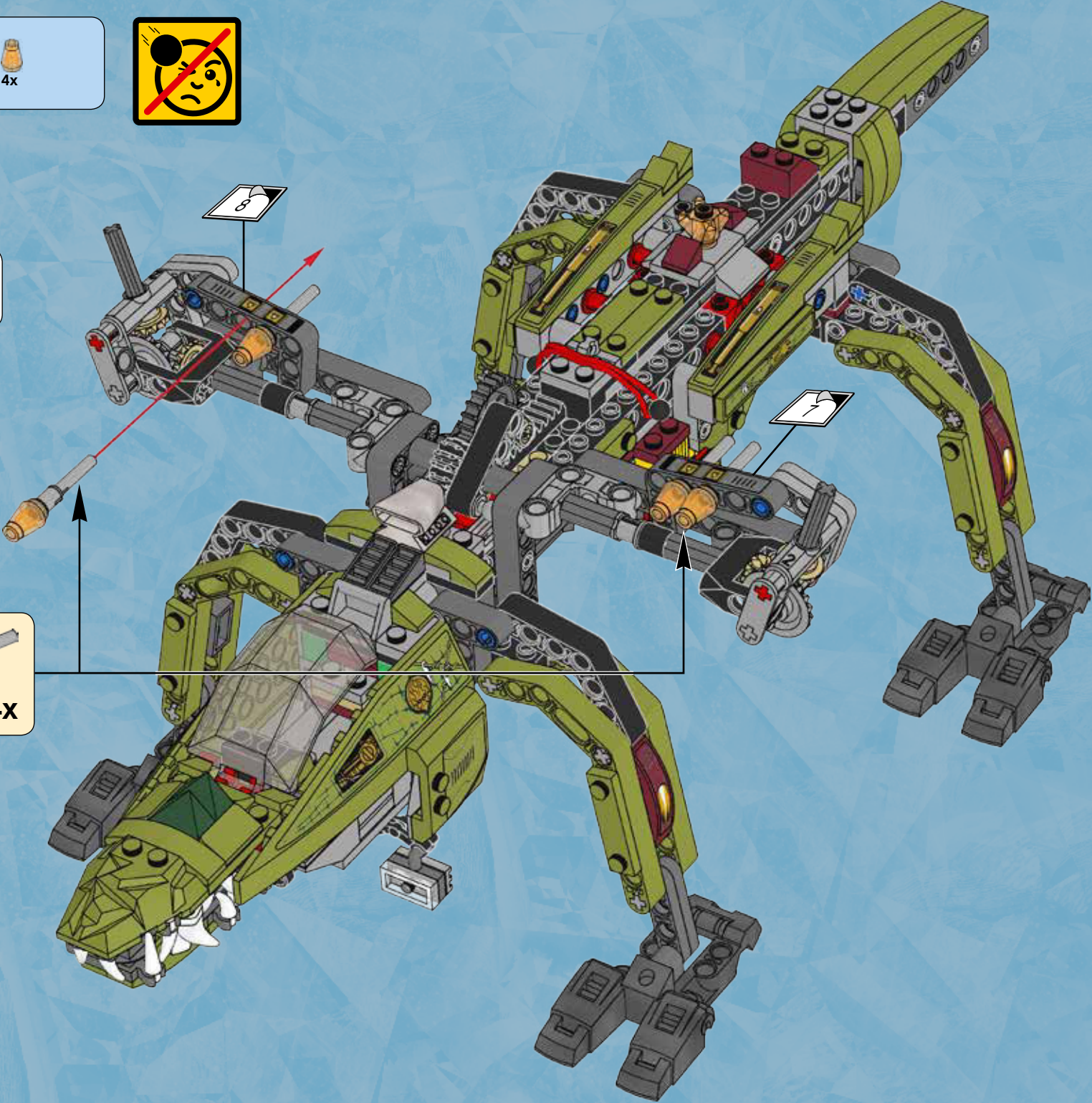



54

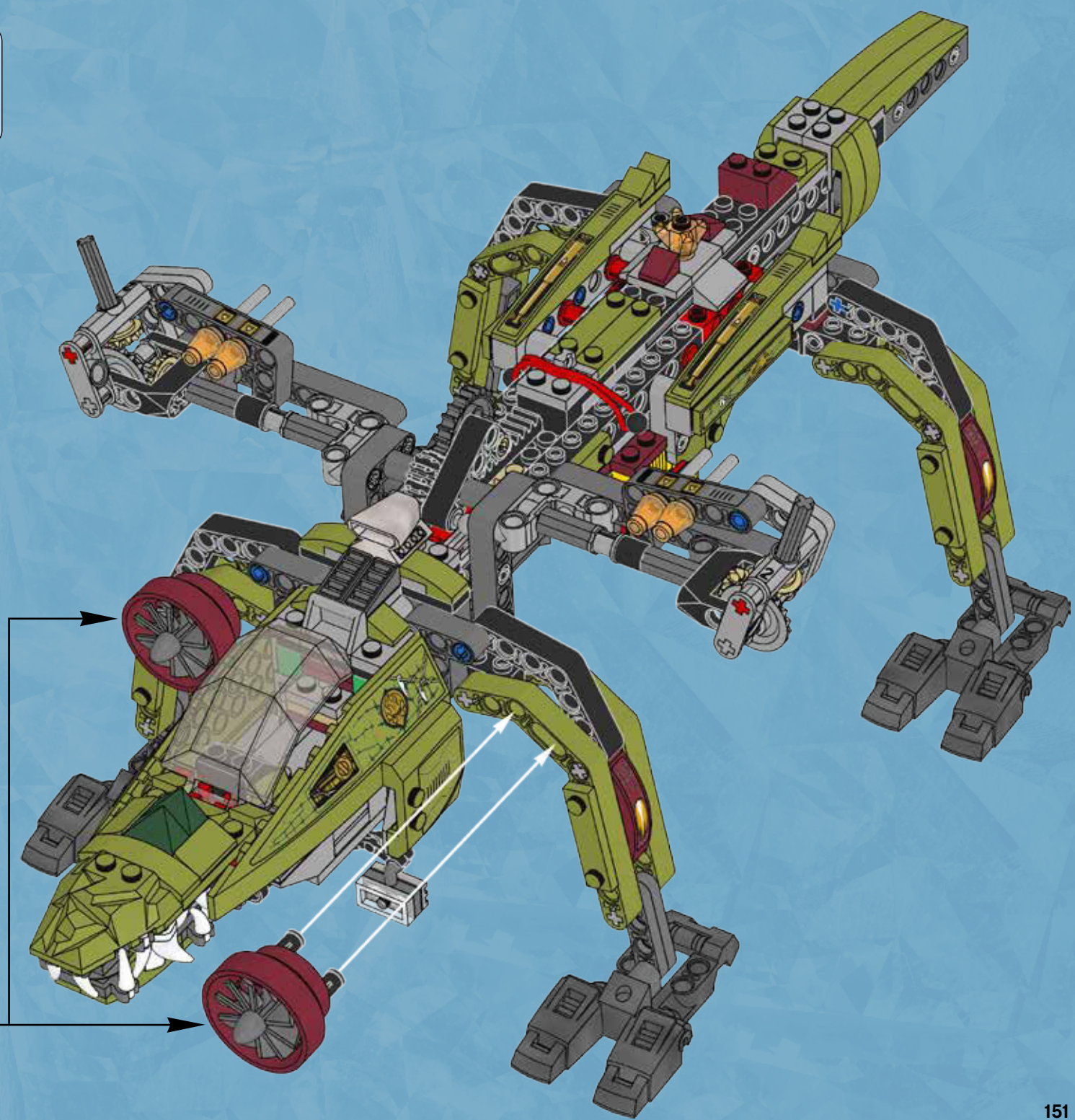
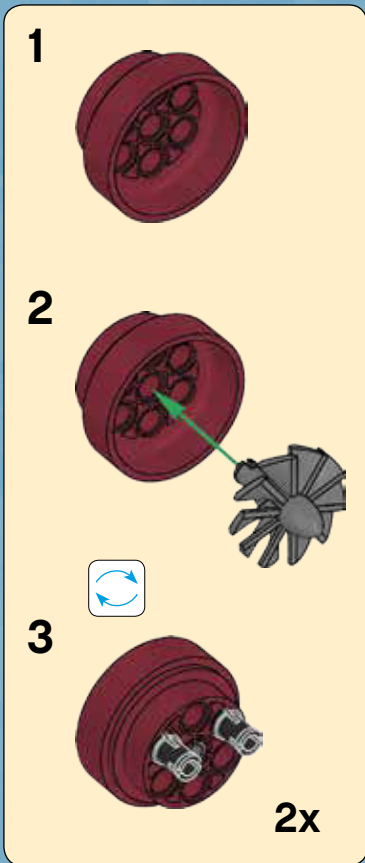

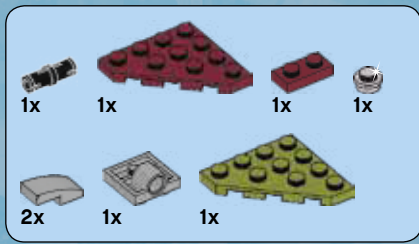

55

1



2

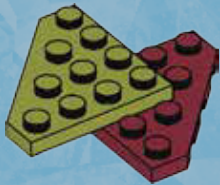

3

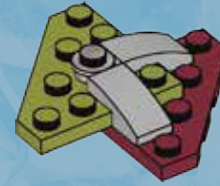

4

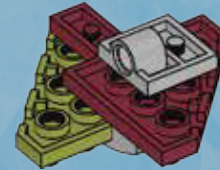

5

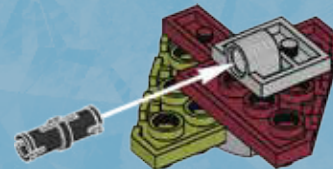

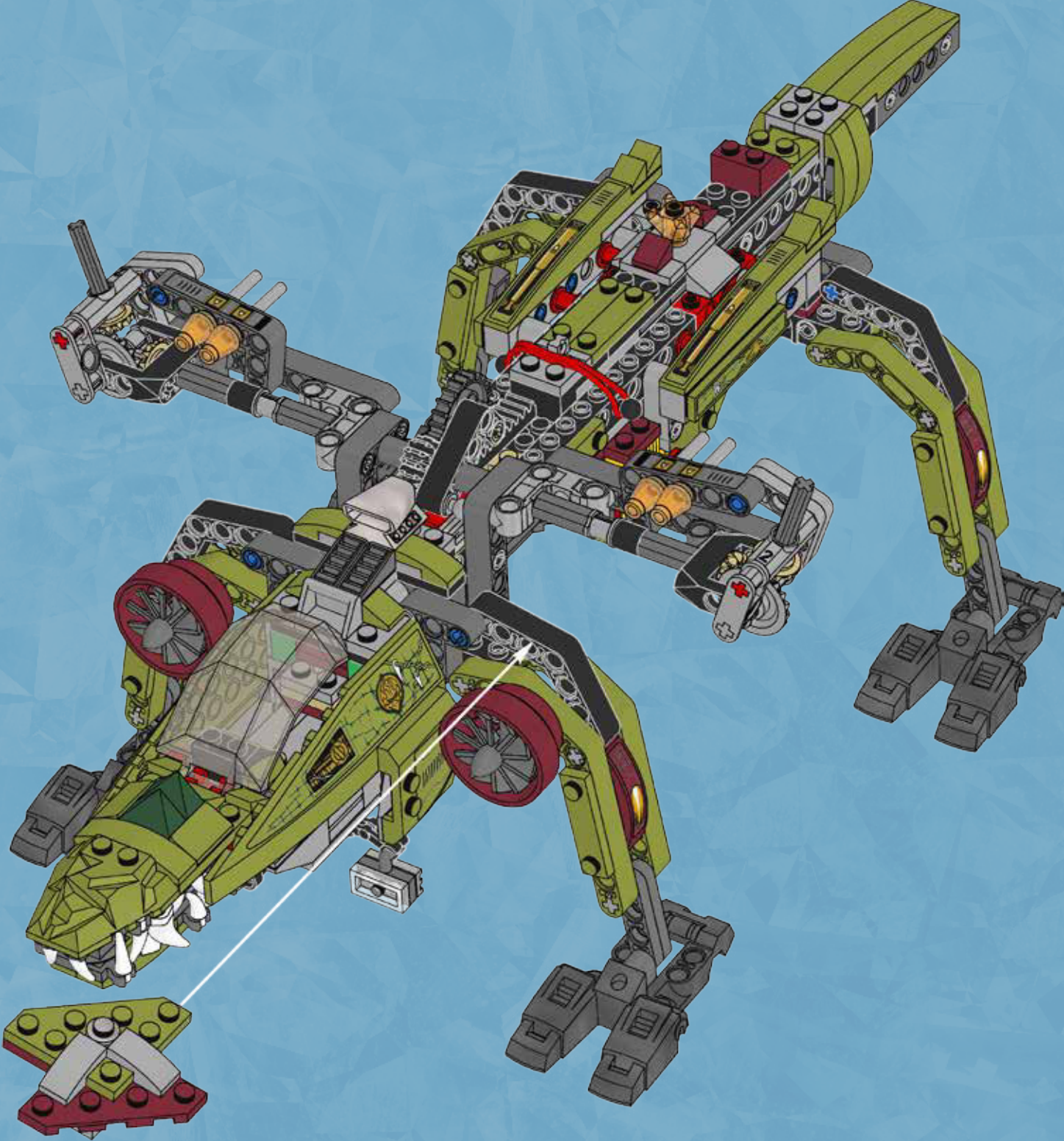

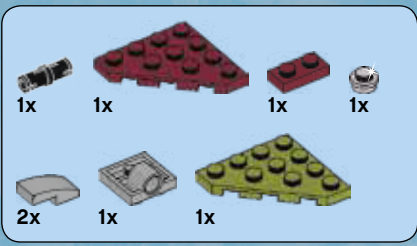

56

1



2

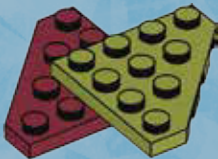

3

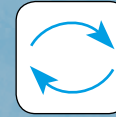
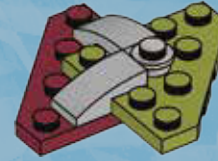

4

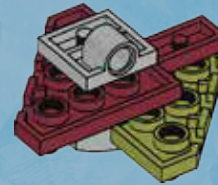

5

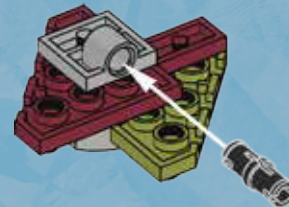

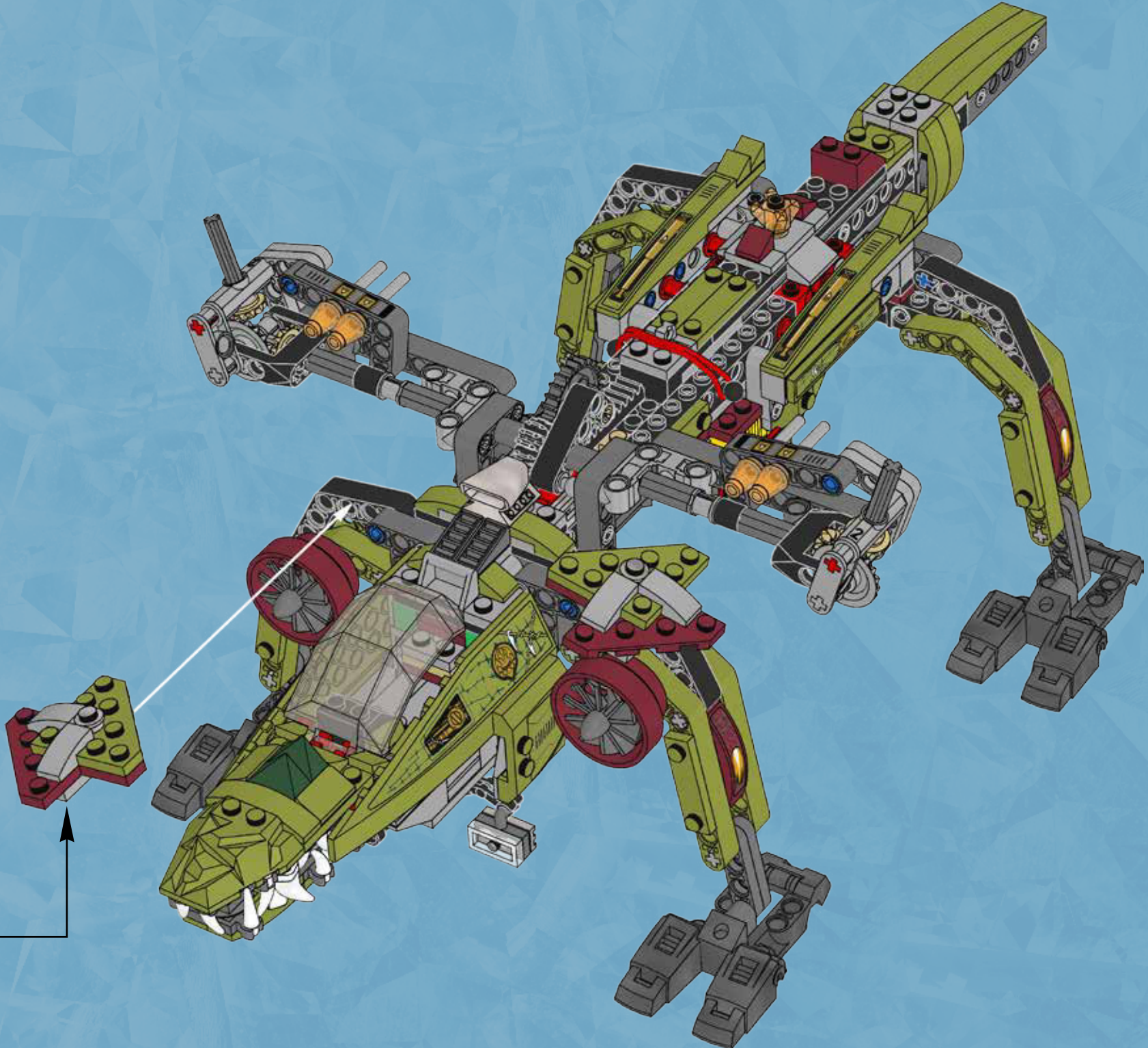

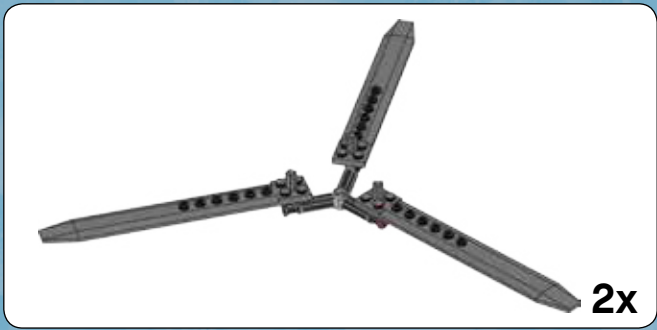

1

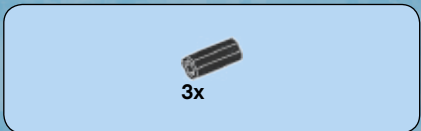

2



3

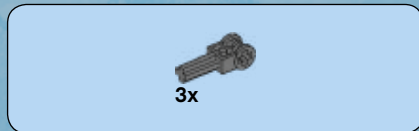
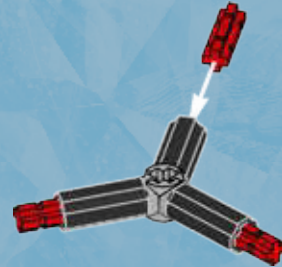

4

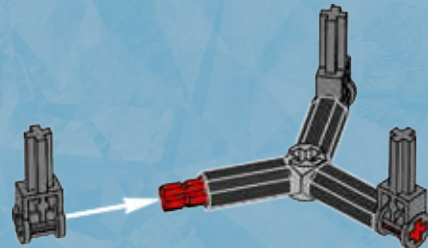

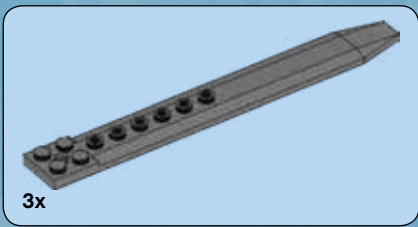

5

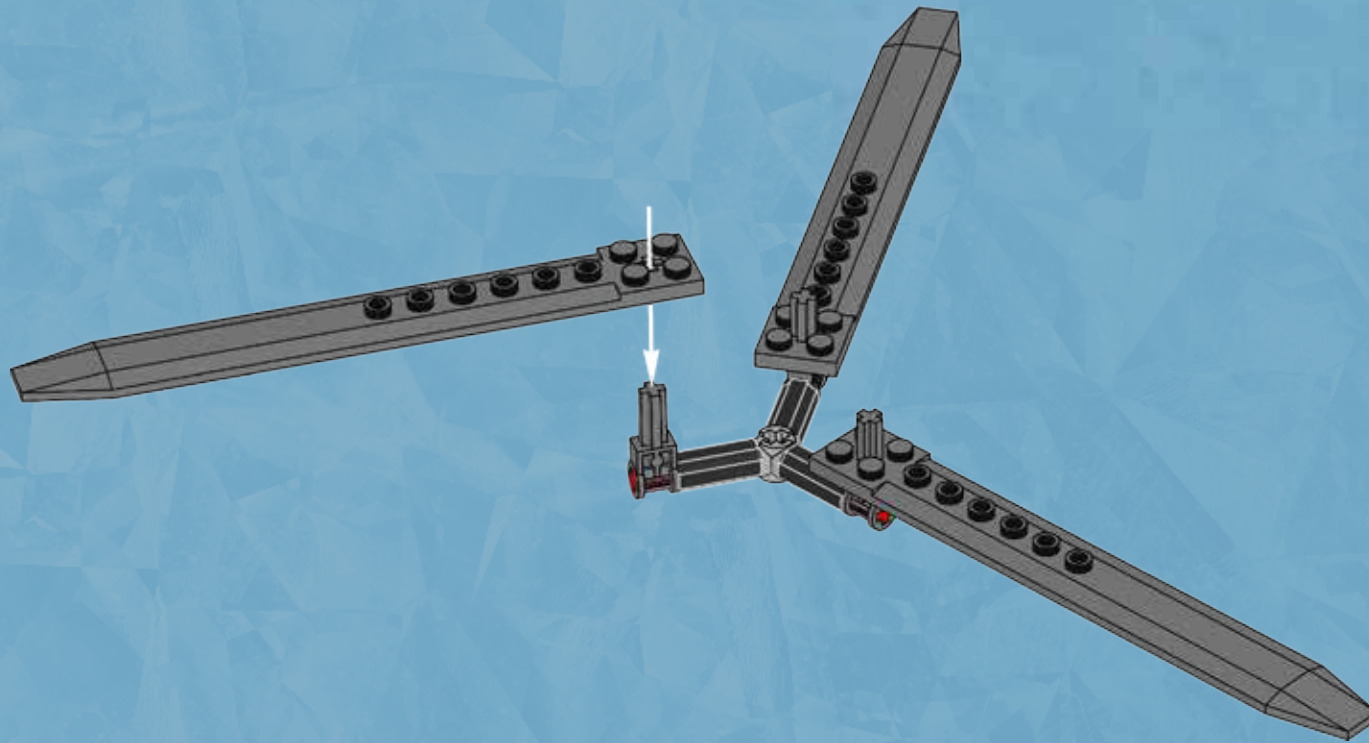

2x

57

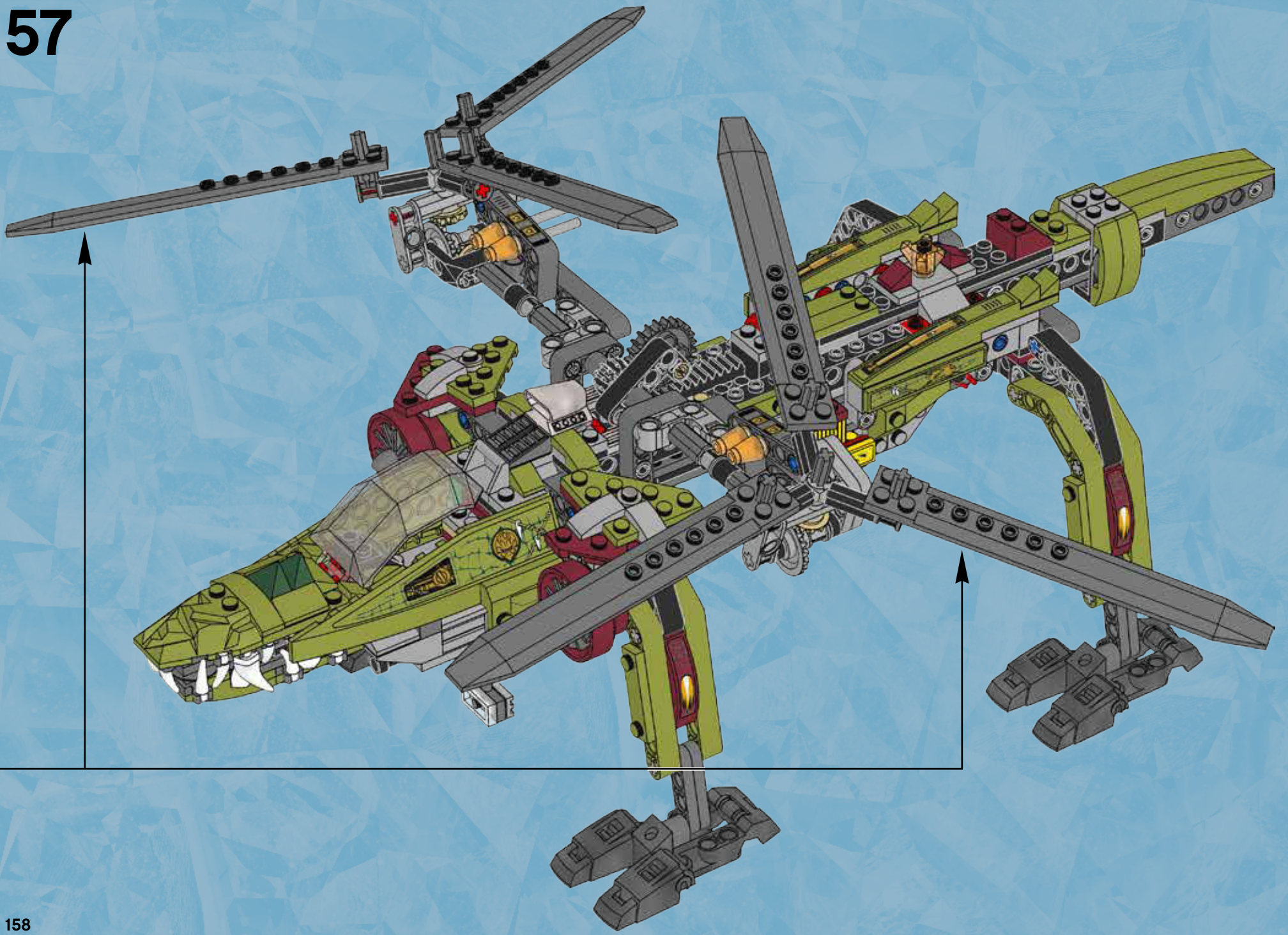



58

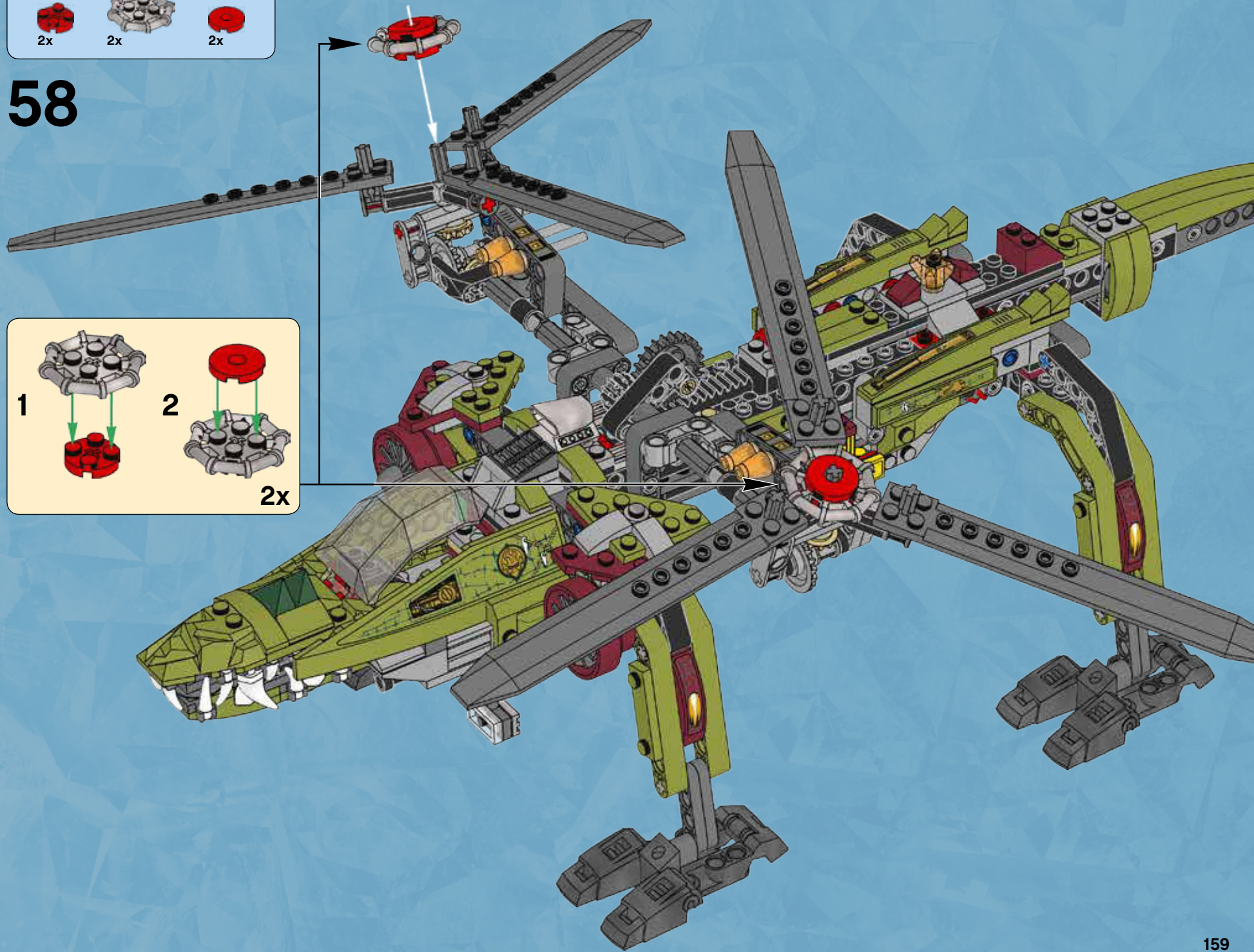
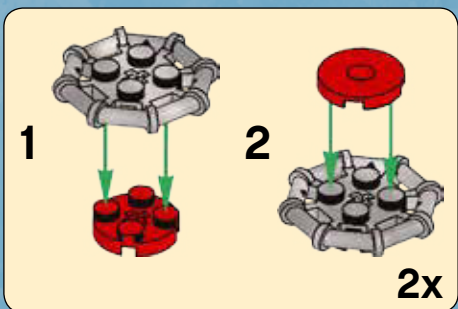

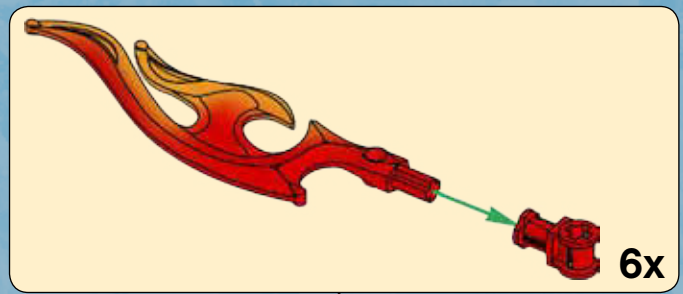
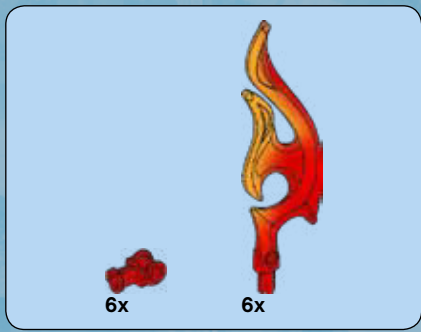

59

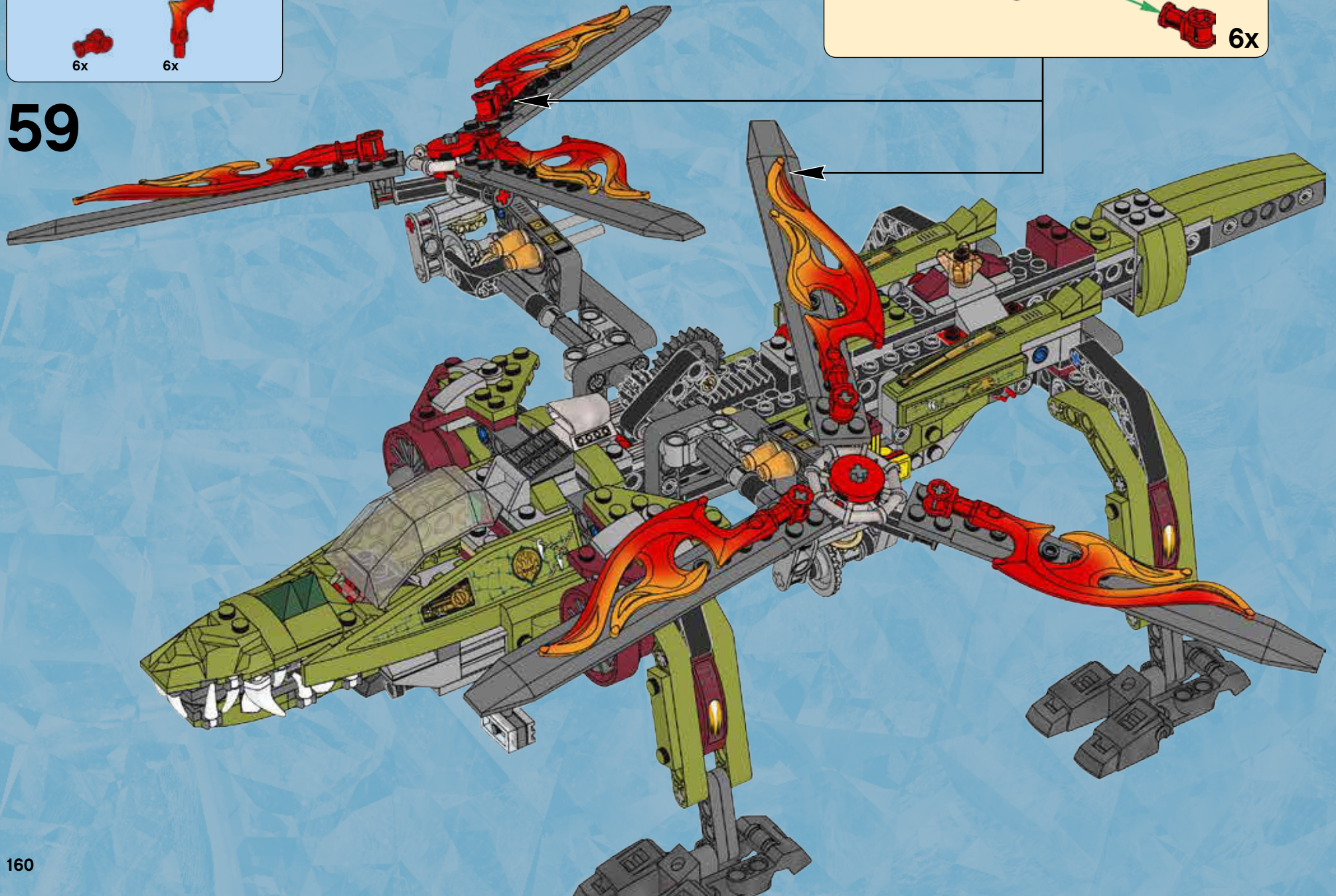

60

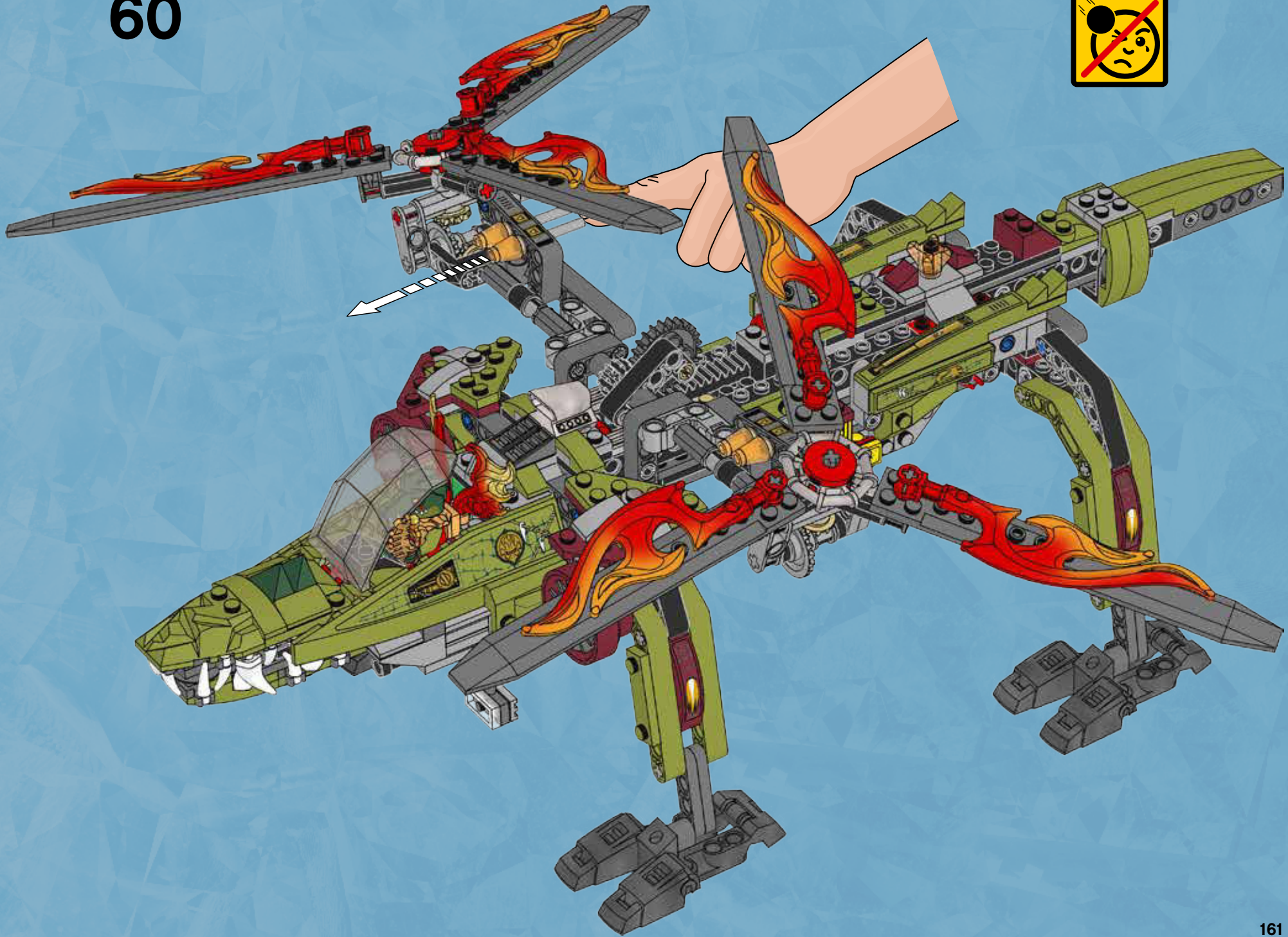

61

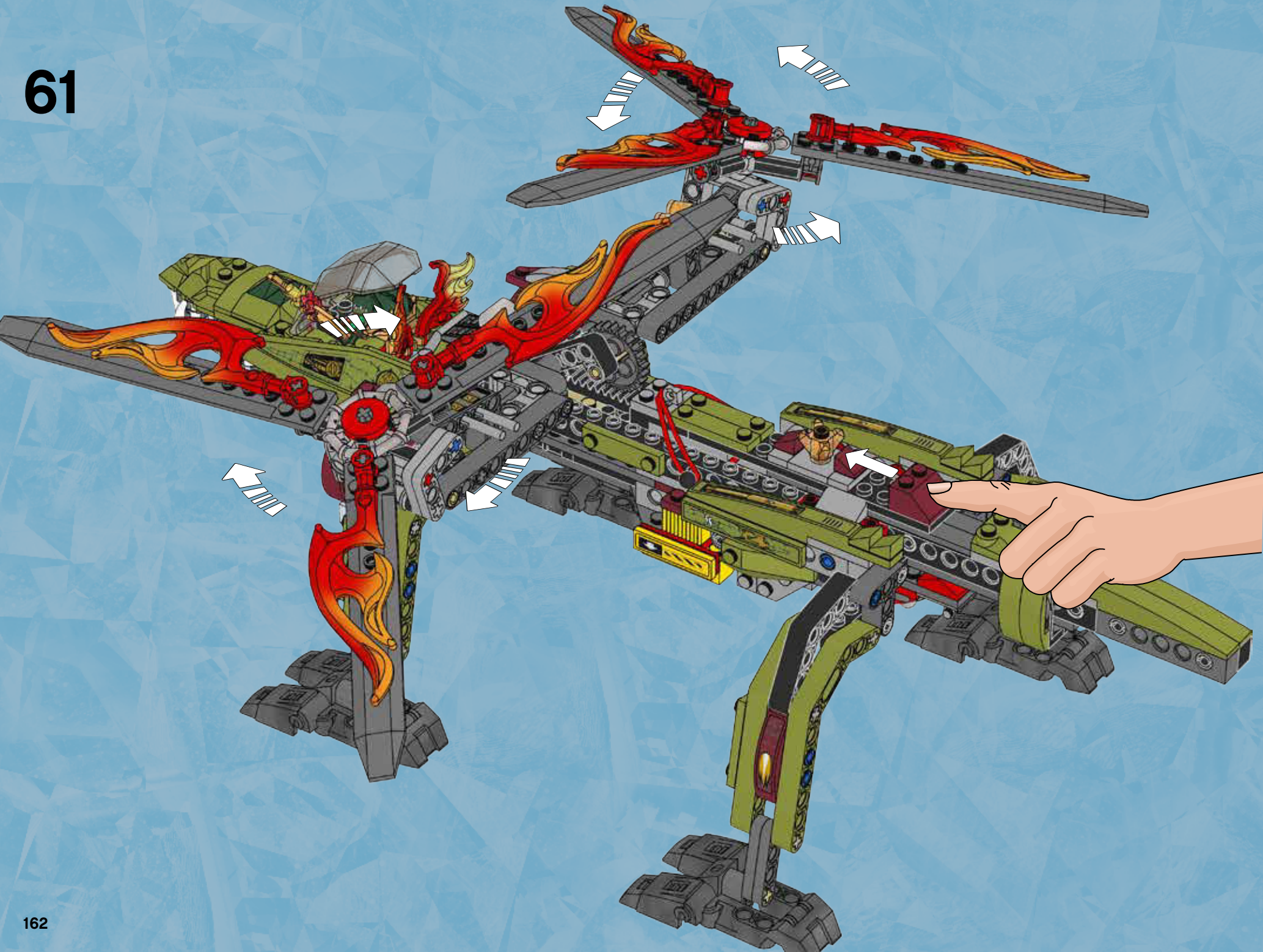

62

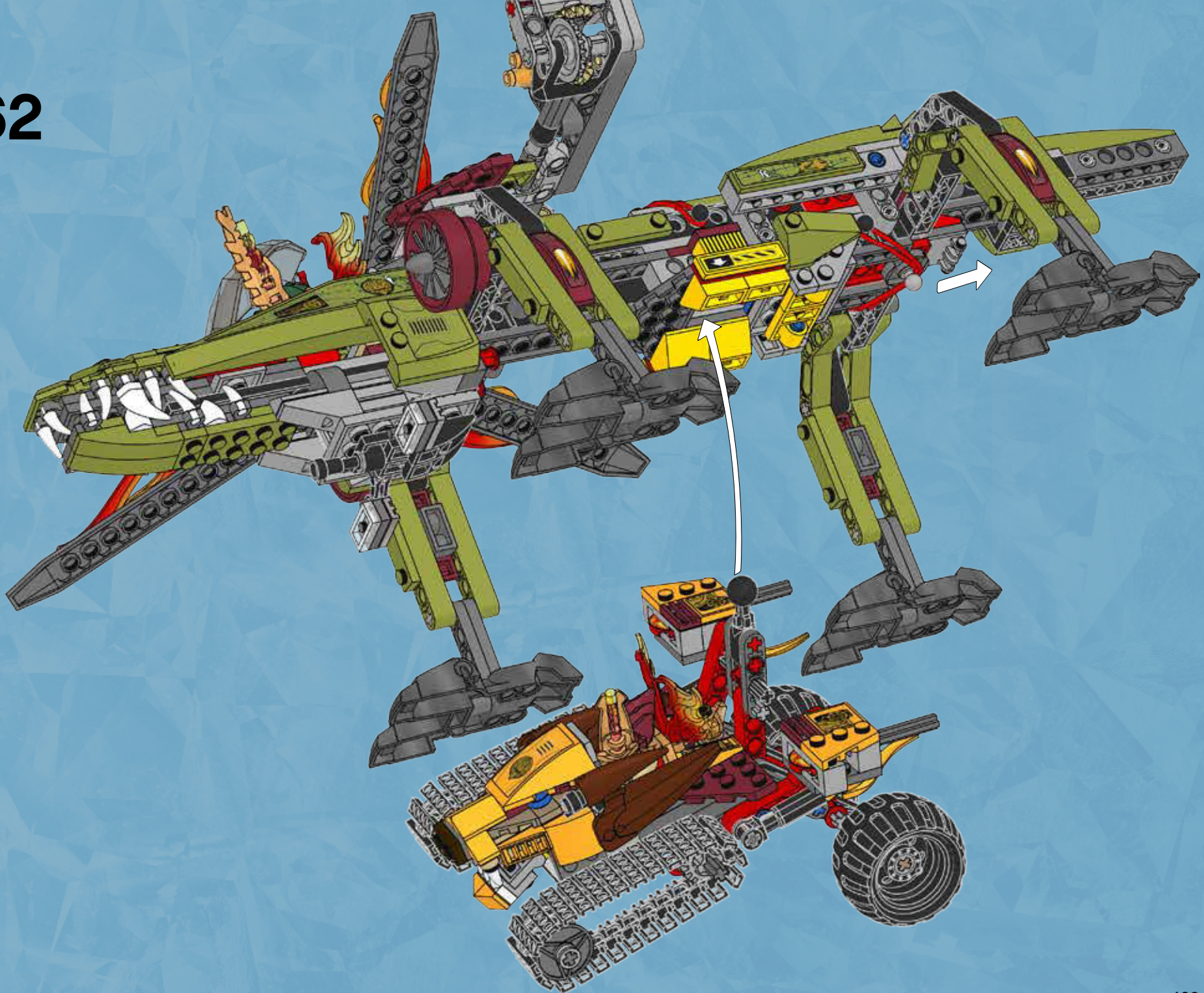

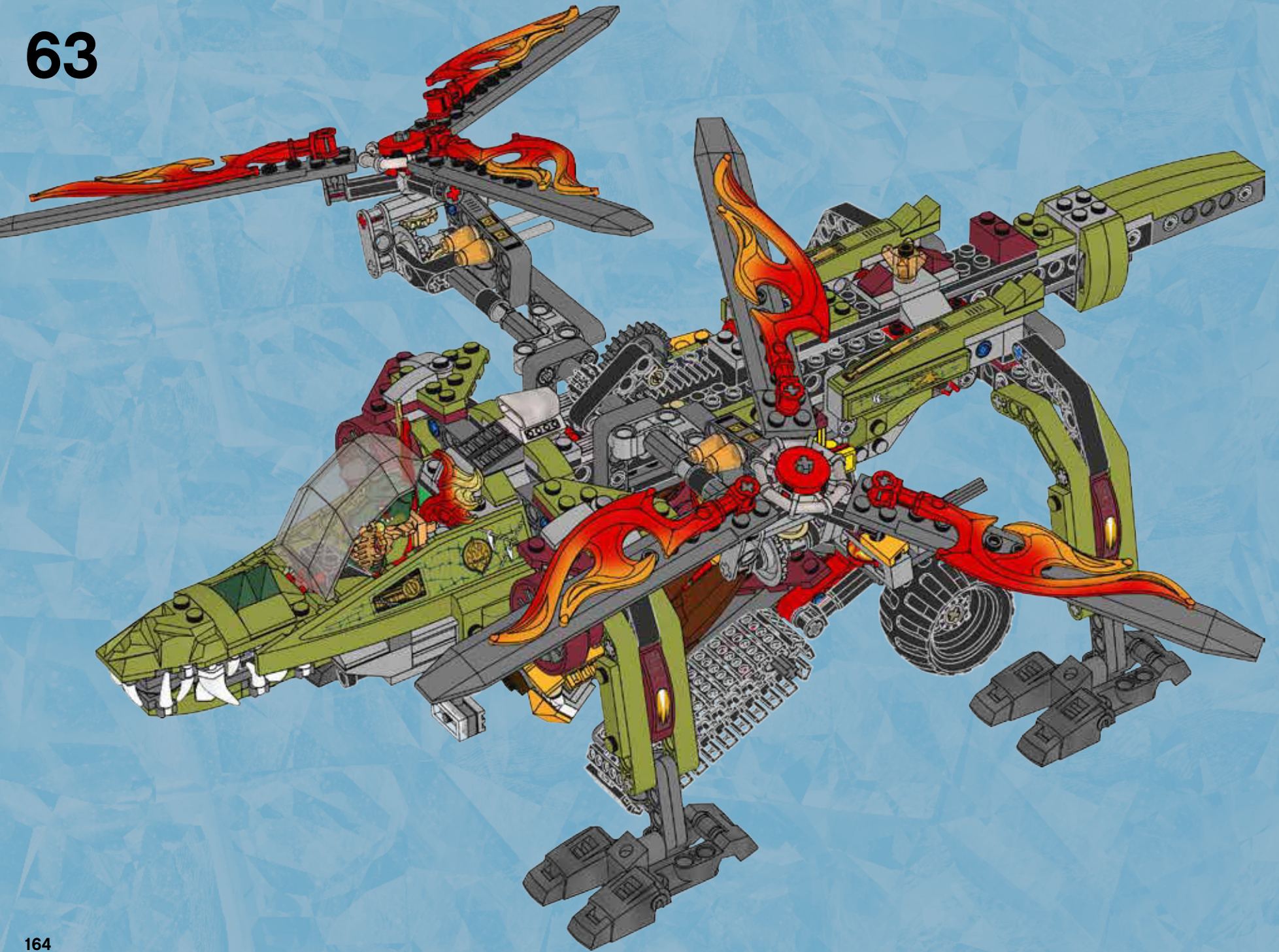

64

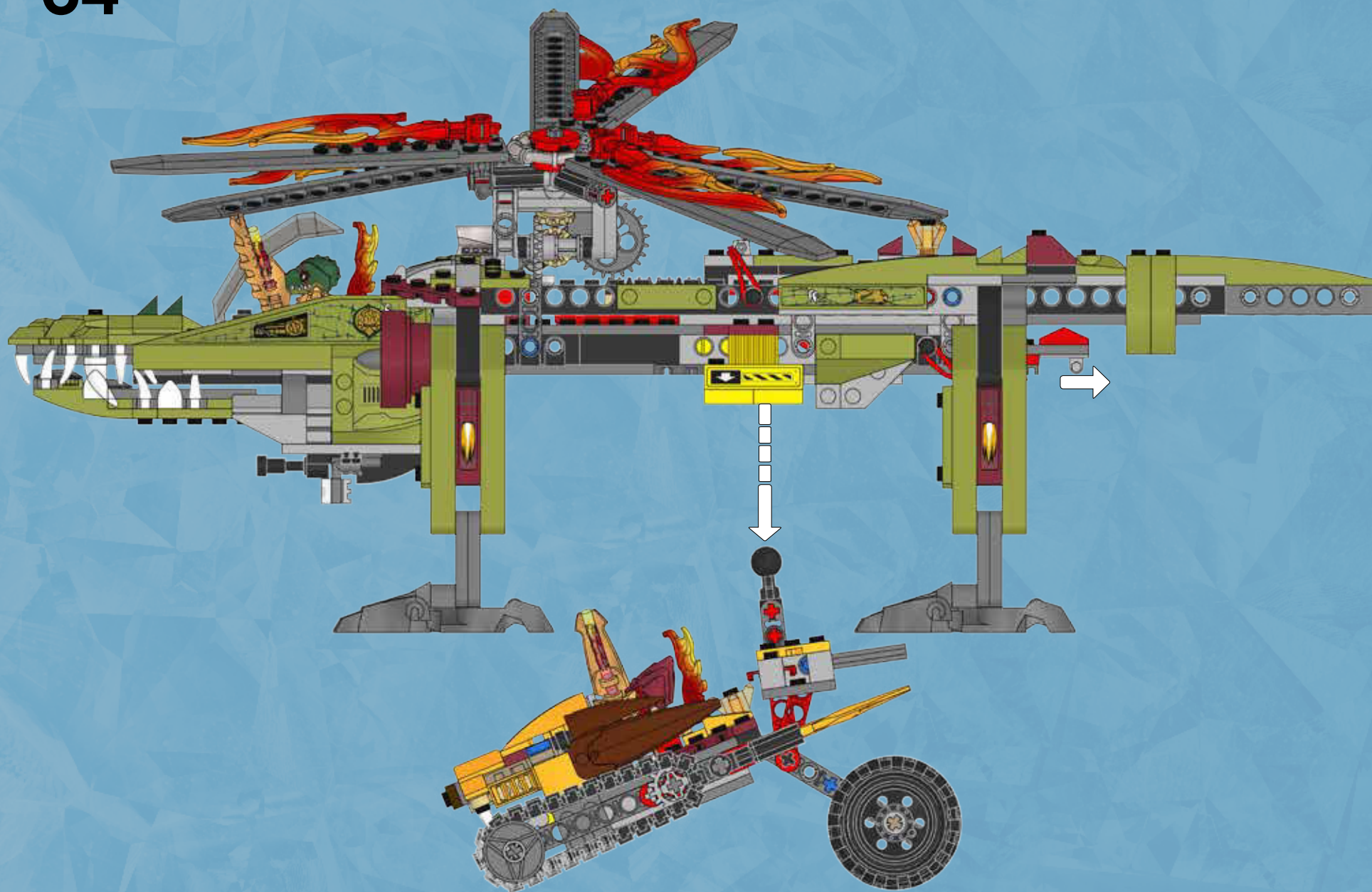

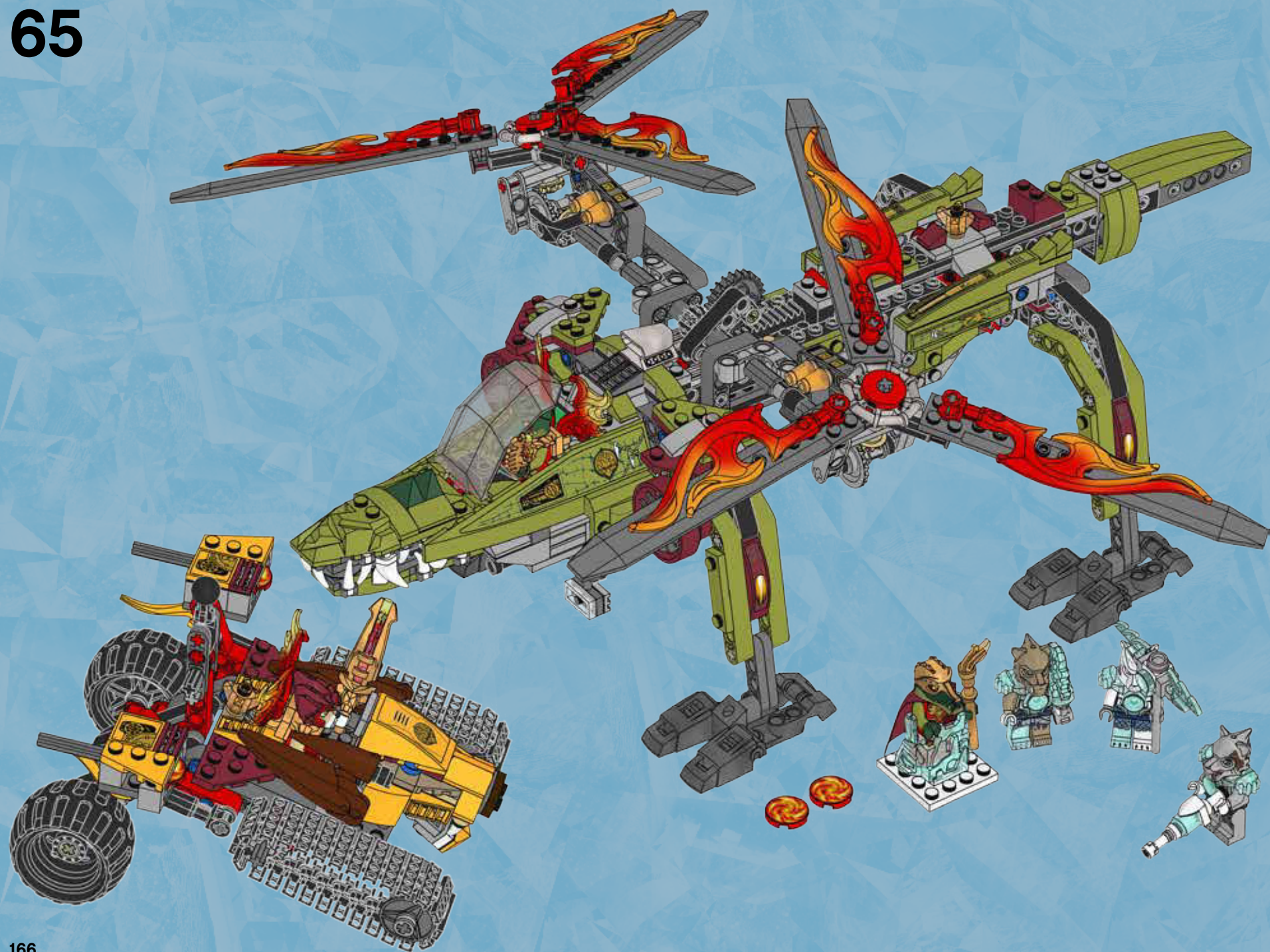

1x 6102369
1x 4111971
1x 6047220
1x 4243812
1x 459901
1x 6100568
1x 6102322
1x 6103906
1x 6040333
16x 4568387
2x 4566256
5x 6046905
1x 6046381
1x 4114077
3x 4118790
3x 4113233
2x 4632573

1x 6021599
2x 6013938
5x 4666579
4x 4565452
2x 300321
3x 370121
1x 330021
2x 6057432
2x 4113858
2x 4597713
4x 6089576
2x 370921
3x 403221
4x 6102613
2x 6102138
6x 4140806
1x 6073764

2x 6073639
2x 6073600
1x 6073752
2x 4544143
3x 4263821
6x 6100700
11x 4227155
14x 4142865
6x 4118897
4x 6097662
2x 6083865
1x 4654448

10x 4206482
18x 4514553
1x 389423
3x 4560180
2x 6009460
26x 4143005
2x 6039869
2x 4632571
6x 6000650
1x 6061032
4x 4223247
1x 4538456
1x 287726
1x 300126
2x 6039194

4x 242026
1x 4560108
2x 4299389
2x 4518826
2x 4143372
1x 4205760
1x 4120017
4x 4529549
4x 4128593
2x 4495935
1x 346026
2x 244526
4x 370326

1x 6024730
2x 6073231
2x 4558692
52x 6047885
4x 4184169
34x 4121715
2x 4107081
8x 4512363
2x 6055630
3x 370526
1x 370726
1x 373726
1x 4177431
1x 4551168
2x 6021493
2x 6068078

2x 4107736
2x 4167842
1x 4183544
4x 6022171
2x 6021974
1x 6053028
3x 6070887
1x 6065032
1x 6030851
3x 6092591
2x 6003379
1x 6074013
1x 6073932
1x 6070269
2x 6055631
1x 6074050

3x 287724
5x 366024
1x 306924
2x 243124
1x 4556156
2x 6061025
2x 6075077
1x 6022515
1x 6022517
1x 6022275
2x 4531415
1x 4609925
4x 6000752
2x 4541506
23x 4539097
2x 4585479
1x 4541544
4x 4539070

1x 6070612
1x 6119414
2x 6030706
4x 4567338
1x 4649066
2x 6066085
4x 6023173
2x 6024286
2x 6099728
2x 6099730
1x 6020141
2x 6020147
1x 6020145
1x 6020146
2x 6099396
4x 6110043



Customer Service
Kundenservice
Service Consommateurs
Servicio Al Consumidor
LEGO.com/service or dial



00800 5346 5555 :



1-800-422-5346 :





LEGENDS OF CHIMA™



70229



70230



70231



70232

LEGO.COM/CHIMA



LEGENDS OF
CHIMA™



LAVAL

70227



CRAGGER

70227



ROGON

70226



BLADVIC

70225



GORZAN

70222



WORRIZ

70220



RAZAR

70223

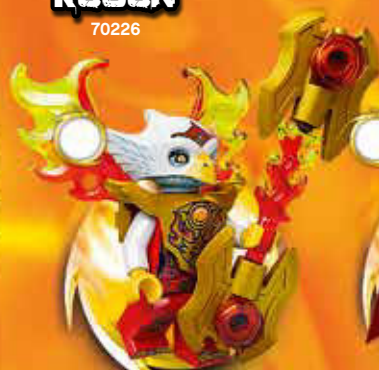

ERIS

70224



CROMNIUS

70227

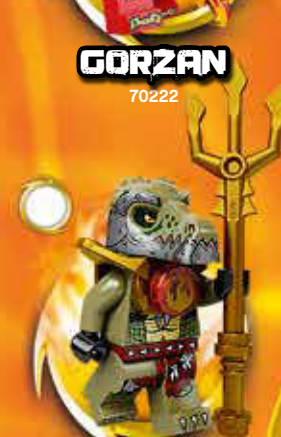

CROKENBURG

70231



LI'ELLA

70229



TORMAK

70222



RINONA

70226



TAZAR

70224



TRAKKAR

70224



BREEZOR

70224



FLINX

70221



BULKAR

70223



SIR FANGAR

70224



STRAINOR

70227



ICEPAW

70227



ICECLAW

70225



VORNON

70225



ICEBITE

70223



SYKOR

70232



SARAW

70227



SIBRESS

70224



MAULA

70226



MOTTROT

70226



SIROX

70232



ICECLAW

70230



VARDY

70226



VOOM VOOM

70221



STRAINOR

70220



ICEPAW

70223



LEGENDS OF
CHIMATM



70227



70225



70226





LEGENDS OF
CHIMA™

70220

70221

70222

70223

70224



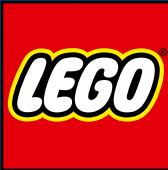

LEGENDS OF CHIMA™

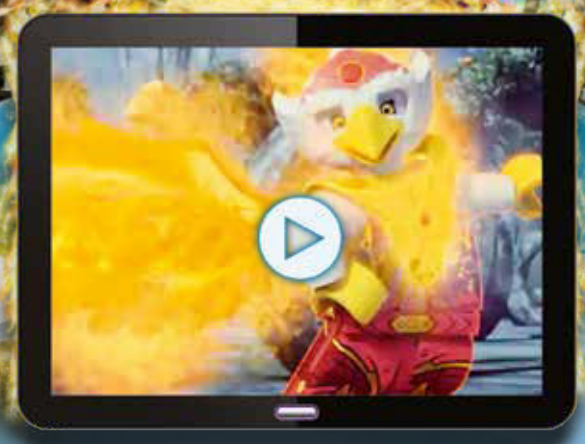

LEGO.COM/CHIMA

...Or visit:



Apple, the Apple logo, iPad, iPhone and iPod touch are trademarks of Apple Inc., registered in the U.S. and other countries. App Store is a service mark of Apple Inc.

Google Play is a trademark of Google Inc.



club™



1

2

3



WIN

GO TO WWW.LEGO.COM/PRODUCTFEEDBACK AND
GIVE US YOUR SHORT **FEEDBACK** ABOUT THIS
LEGO® SET FOR A CHANCE TO WIN
A COOL LEGO PRIZE.



LEGO.com/productfeedback

GEWINNE



Erzähle uns auf
www.LEGO.com/productfeedback

etwas über die Erfahrungen, die
du mit diesem LEGO® Set gemacht
hast, und sichere dir die Chance
auf einen coolen LEGO Preis!

GAGNE



Rends-toi sur
www.LEGO.com/productfeedback

et donne-nous quelques com-
mentaires sur ce produit LEGO®
pour avoir une chance de gagner
un prix LEGO !

GANAN



Visita
www.LEGO.com/productfeedback

y envíanos tu opinión acerca de
este set LEGO®. ¡Participarás en el
sorteo de un premio LEGO!

获取奖品



登录
www.LEGO.com/productfeedback

给出关于此乐高®套装的简短反馈，
就有机会获得炫酷乐高奖品

경품 당첨 기회



www.LEGO.com/productfeedback

페이지로 이동하여 이 레고® 세트에
대한 간략한 피드백을 보내 주시고
멋진 레고 경품을 탈 수 있는 기회도
잡으십시오

ЗАПОЛНИ АНКЕТУ И ПОЛУЧИ ПРИЗ



Перейди по ссылке
www.LEGO.com/productfeedback

ответь всего на несколько во-
просов об этом наборе LEGO®,
и у тебя появится шанс выиграть
замечательный приз от компании
LEGO.